

**Product number C11415_STRADA-T-DN**

Family	Strada	FWHM	Asymmetric degrees
Type	Lens	Efficiency	92 %
LED	XP-G	cd/lm	-
Color	Clear	Gerber File	Available
Diameter	19.8 x 15.5 mm		
Height	8.75 mm		
Style	Rectang		
Optic Material	PMMA		
Holder Material	-		
Fastening	["screw", "glue", "pin"]		
Status	Production ready		

**Product number CA11416_STRADA-T-DN**

Family	Strada	FWHM	Asymmetric degrees
Type	Assembly	Efficiency	92 %
LED	XP-G	cd/lm	-
Color	Clear	Gerber File	Available
Diameter	19.8 x 15.5 mm		
Height	8.75 mm		
Style	Rectang		
Optic Material	PMMA		
Holder Material	-		
Fastening	["tape", "pin", "screw"]		
Status	Production ready		

**Product number C11425_STRADA-T-DW**

Family	Strada	FWHM	Asymmetric degrees
Type	Lens	Efficiency	93 %
LED	XP-G	cd/lm	-
Color	Clear	Gerber File	Available
Diameter	19.6 x 15.5 mm		
Height	10.7 mm		
Style	Rectang		
Optic Material	PMMA		
Holder Material	-		
Fastening	["pin", "tape"]		
Status	Production ready		

**Product number CA11426_STRADA-T-DW**

Family	Strada	FWHM	Asymmetric degrees
Type	Assembly	Efficiency	92 %
LED	XP-G	cd/lm	-
Color	Clear	Gerber File	Available
Diameter	19.6 x 15.5 mm		
Height	10.7 mm		
Style	Rectang		
Optic Material	PMMA		
Holder Material	-		
Fastening	["pin", "tape", "screw"]		
Status	Production ready		

Product number 2F11896_STRADA-T-DN-EP

Family	Strada	FWHM	Asymmetric degrees
Type	Lens	Efficiency	92 %
LED	XP-G	cd/lm	-
Color	Clear	Gerber File	Available
Diameter	19.8 x 15.5 mm	No position element, Customer needs own fixture for assembling	
Height	8.75 mm		
Style	Rectang		
Optic Material	PMMA		
Holder Material	-		
Fastening	["glue", "screw"]		
Status	Production ready		

Product number 2F11898_STRADA-T-DW-EP

Family	Strada	FWHM	Asymmetric degrees
Type	Lens	Efficiency	92 %
LED	XP-G	cd/lm	-
Color	Clear	Gerber File	Available
Diameter	19.6 x 15.5 mm	No position element, Customer needs own fixture for assembling	
Height	10.7 mm		
Style	Rectang		
Optic Material	PMMA		
Holder Material	-		
Fastening	["glue", "screw"]		
Status	Production ready		

Product number 2FA11992_STRADA-T-DN-EP

Family	Strada	FWHM	Asymmetric degrees
Type	Assembly	Efficiency	92 %
LED	XP-G	cd/lm	-
Color	Clear	Gerber File	Available
Diameter	19.8 x 15.5 mm	No position element, Customer needs own fixture for assembling	
Height	8.75 mm		
Style	Rectang		
Optic Material	PMMA		
Holder Material	-		
Fastening	["tape", "screw"]		
Status	Production ready		

Product number 2FA11993_STRADA-T-DW-EP

Family	Strada	FWHM	Asymmetric degrees
Type	Assembly	Efficiency	92 %
LED	XP-G	cd/lm	-
Color	Clear	Gerber File	Available
Diameter	19.6 x 15.5 mm	No position element, Customer needs own fixture for assembling	
Height	10.7 mm		
Style	Rectang		
Optic Material	PMMA		
Holder Material	-		
Fastening	["tape", "screw"]		
Status	Production ready		

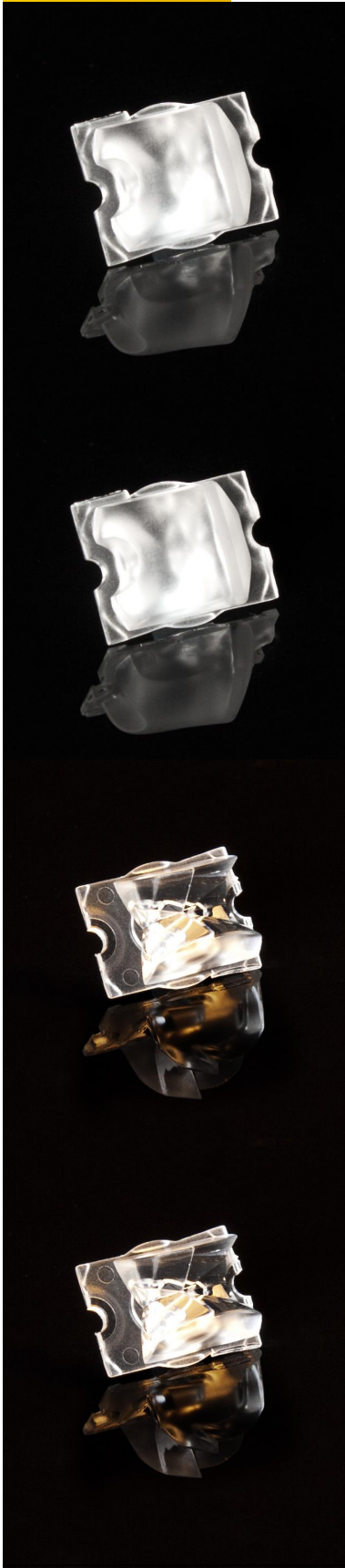
**Product number C12049_STRADA-FT**

Family	Strada
Type	Lens
LED	XP-G
Color	Clear
Diameter	15.4 x 19.6 mm
Height	8.2 mm
Style	Rectang
Optic Material	PMMA
Holder Material	-
Fastening	["screw", "glue", "pin"]
Status	Production ready

FWHM	Asymmetric degrees
Efficiency	88 %
cd/Im	-
Gerber File	Available

http://www.ledil.fi/Strada-F_Fully_Asymmetrical_Forward_Throw_Lens_Family

Product number CA12050_STRADA-FT

Family	Strada
Type	Assembly
LED	XP-G
Color	Clear
Diameter	15.4 x 19.6 mm
Height	8.35 mm
Style	Rectang
Optic Material	PMMA
Holder Material	-
Fastening	["tape", "pin", "screw"]
Status	Production ready

FWHM	Asymmetric degrees
Efficiency	88 %
cd/Im	-
Gerber File	Available

http://www.ledil.fi/Strada-F_Fully_Asymmetrical_Forward_Throw_Lens_Family

Product number C12086_STRADA-FW

Family	Strada
Type	Lens
LED	XP-G
Color	Clear
Diameter	15.4 x 19.6 mm
Height	10.66 mm
Style	Rectang
Optic Material	PMMA
Holder Material	-
Fastening	["pin", "screw", "glue"]
Status	Production ready

FWHM	Asymmetric degrees
Efficiency	92 %
cd/Im	-
Gerber File	Available

http://www.ledil.fi/Strada-F_Fully_Asymmetrical_Forward_Throw_Lens_Family

Product number CA12087_STRADA-FW

Family	Strada
Type	Assembly
LED	XP-G
Color	Clear
Diameter	15.4 x 19.6 mm
Height	10.8 mm
Style	Rectang
Optic Material	PMMA
Holder Material	-
Fastening	["tape", "pin", "screw"]
Status	Production ready

FWHM	Asymmetric degrees
Efficiency	92 %
cd/Im	-
Gerber File	Available

http://www.ledil.fi/Strada-F_Fully_Asymmetrical_Forward_Throw_Lens_Family

**Product number C12219_STRADA-A2**

Family	Strada	FWHM	72+144 degrees
Type	Lens	Efficiency	92 %
LED	XP-G	cd/lm	0.850
Color	Clear	Gerber File	Available
Diameter	19.6 +15.4 mm		
Height	10.5 mm		
Style	Rectang		
Optic Material	PMMA		
Holder Material	-		
Fastening	["glue", "screw", "pin"]		
Status	Production ready		

**Product number CA12220_STRADA-A2**

Family	Strada	FWHM	72+ 144 degrees
Type	Assembly	Efficiency	92 %
LED	XP-G	cd/lm	0.850
Color	Clear	Gerber File	Available
Diameter	19.6 +15.4 mm		
Height	10.65 mm		
Style	Rectang		
Optic Material	PMMA		
Holder Material	-		
Fastening	["screw", "pin", "tape"]		
Status	Production ready		

**Product number C10818_STRADA-A**

Family	Strada	FWHM	80+144 degrees
Type	Lens	Efficiency	93 %
LED	XP-G	cd/lm	0.850
Color	Clear	Gerber File	Available
Diameter	19.6 +15.4 mm		
Height	10.5 mm		
Style	Rectang		
Optic Material	PMMA		
Holder Material	-		
Fastening	["glue", "screw"]		
Status	Production ready		

**Product number CA10823_STRADA-A**

Family	Strada	FWHM	80+144 degrees
Type	Assembly	Efficiency	93 %
LED	XP-G	cd/lm	0.850
Color	Clear	Gerber File	Available
Diameter	19.6 +15.4 mm		
Height	10.65 mm		
Style	Rectang		
Optic Material	PMMA		
Holder Material	-		
Fastening	["tape", "screw"]		
Status	Production ready		

**Product number C11255_STRADA-DW**

Family	Strada	FWHM	88+148 degrees
Type	Lens	Efficiency	92 %
LED	XP-G	cd/lm	0.840
Color	Clear	Gerber File	Available
Diameter	19.6 x 15.7 mm		
Height	9 mm		
Style	Rectang		
Optic Material	PMMA		
Holder Material	-		
Fastening	-		
Status	Production ready		

**Product number CA11256_STRADA-DW**

Family	Strada	FWHM	88+148 degrees
Type	Assembly	Efficiency	92 %
LED	XP-G	cd/lm	0.840
Color	Clear	Gerber File	Available
Diameter	19.6 x 15.7 mm		
Height	9 mm		
Style	Rectang		
Optic Material	PMMA		
Holder Material	-		
Fastening	["screw", "pin", "tape"]		
Status	Production ready		

**Product number C10926_STRADA-B**

Family	Strada	FWHM	112+42 degrees
Type	Lens	Efficiency	93 %
LED	XP-G	cd/lm	0.500
Color	Clear	Gerber File	Available
Diameter	19.6 + 15.5 mm		
Height	5.2 mm		
Style	Rectang		
Optic Material	PMMA		
Holder Material	-		
Fastening	["glue", "screw"]		
Status	Production ready		

**Product number CA10927_STRADA-B**

Family	Strada	FWHM	112+42 degrees
Type	Assembly	Efficiency	93 %
LED	XP-G	cd/lm	0.500
Color	Clear	Gerber File	Available
Diameter	19.6 + 15.5 mm		
Height	5.2 mm		
Style	Rectang		
Optic Material	PMMA		
Holder Material	-		
Fastening	["tape", "screw"]		
Status	Production ready		

Product number CA11253_STRADA-C2

Family	Strada	FWHM	132 degrees
Type	Assembly	Efficiency	92 %
LED	XP-G	cd/lm	0.240
Color	Clear	Gerber File	Available
Diameter	19.6 x 15.6 mm		
Height	5.9 mm		
Style	Rectang		
Optic Material	PMMA		
Holder Material	-		
Fastening	["tape", "pin"]		
Status	Production ready		

Product number CA11248_STRADA-S

Family	Strada	FWHM	144+176 degrees
Type	Assembly	Efficiency	93 %
LED	XP-G	cd/lm	0.350
Color	Clear	Gerber File	Available
Diameter	19.6 x 15.5 mm		
Height	6.9 mm		
Style	Rectang		
Optic Material	PMMA		
Holder Material	-		
Fastening	["pin", "tape", "screw"]		
Status	Production ready		

Developed especially for side emitting applications

Product number C11249_STRADA-S

Family	Strada	FWHM	144+176 degrees
Type	Lens	Efficiency	93 %
LED	XP-G	cd/lm	0.350
Color	Clear	Gerber File	Available
Diameter	19.6 x 15.5 mm		
Height	6.9 mm		
Style	Rectang		
Optic Material	PMMA		
Holder Material	-		
Fastening	["pin", "screw"]		
Status	Production ready		

Developed especially for side emitting applications

NOTE: The typical divergence will be changed by different color, chip size and chip position tolerance. The typical total divergence is the full angle measured where the luminous intensity is half of the peak value.



PRODUCT DATASHEET

Strada series

last update 19/10/2015

GENERAL INFORMATION

- Product series especially designed & optimized for XP-G series of LEDs.
- Special care taken to make light distribution as uniform as possible.
- Lens material optical grade PMMA with high UV and temperature resistance. Allows use of high current and temperature conditions.

Please find more information about used material from below:

http://ledil.fi/sites/default/files/Documents/Technical/Material/PMMA%20N%20UL94_Yellow%20Card.pdf

<http://ledil.fi/sites/default/files/Documents/Technical/Material/PMMA%20N%20PLEXIGLAS-Datasheet.pdf>

D C B A

4

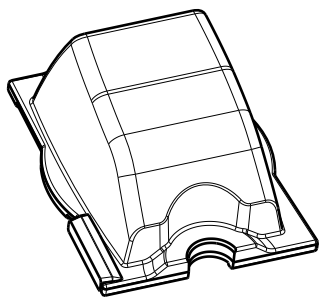

Isometric view

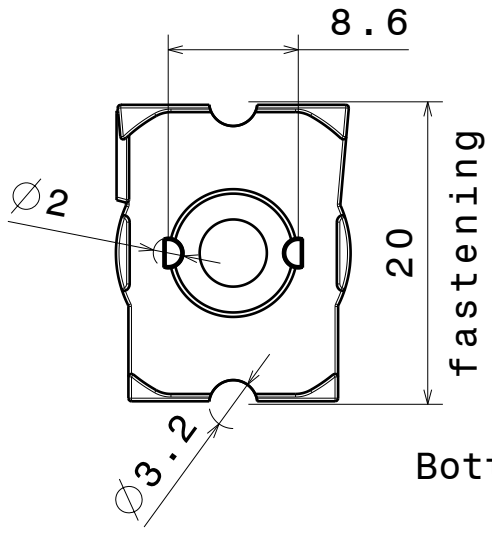

Bottom view

3

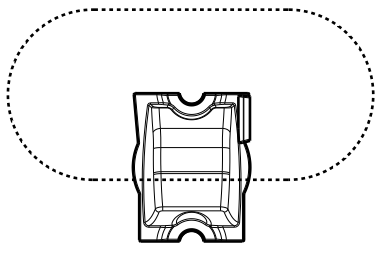

Beam direction

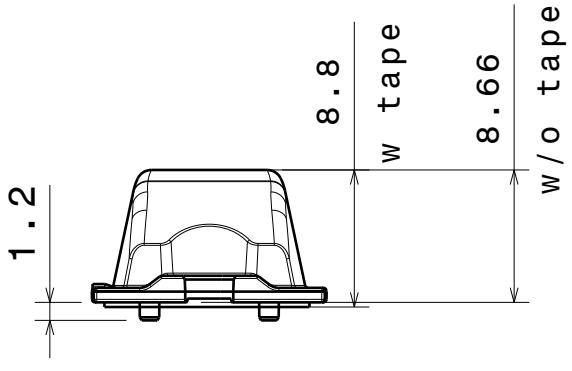

Front view

2

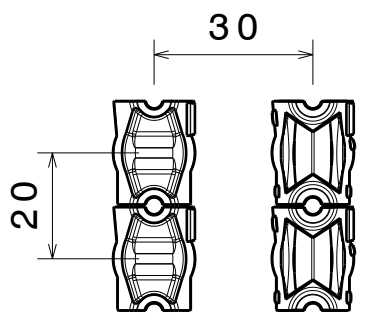

Strada lens arrangement recommendation

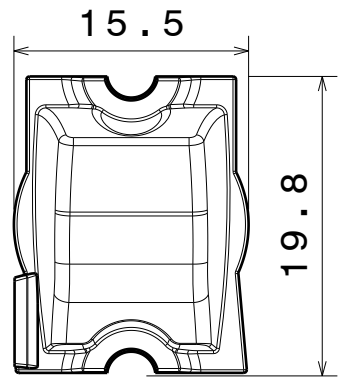

Top view

MATERIALS
 Lens: PMMA
 Tape(optional): PU Foam

Optical interface details are confidential and detail in this area may not reflect actual shape

1

1

This drawing is our property. It can't be reproduced or communicated without our written agreement.		 Ledil Oy Salorankatu 10 FIN-24100 SALO Finland	
DRAWING TITLE			
DRAWN BY ah	DATE 26.9.2012	Datasheet Strada-T-DN Lens	
CHECKED BY sn	DATE 26.9.2012	SIZE A4	DRAWING NUMBER
DESIGNED BY hh	DATE 14.05.2010	SCALE 2:1	WEIGHT (g)
		SHEET 1/1	

D A

Ledil Oy C11415_Strada-T-DN-XP-G C11415_Strada-T-DN-XP-G / LDC (Linear)

Luminaire: Ledil Oy C11415_Strada-T-DN-XP-G C11415_Strada-T-DN-XP-G
Lamps: 1 x Cree XP-G (White)

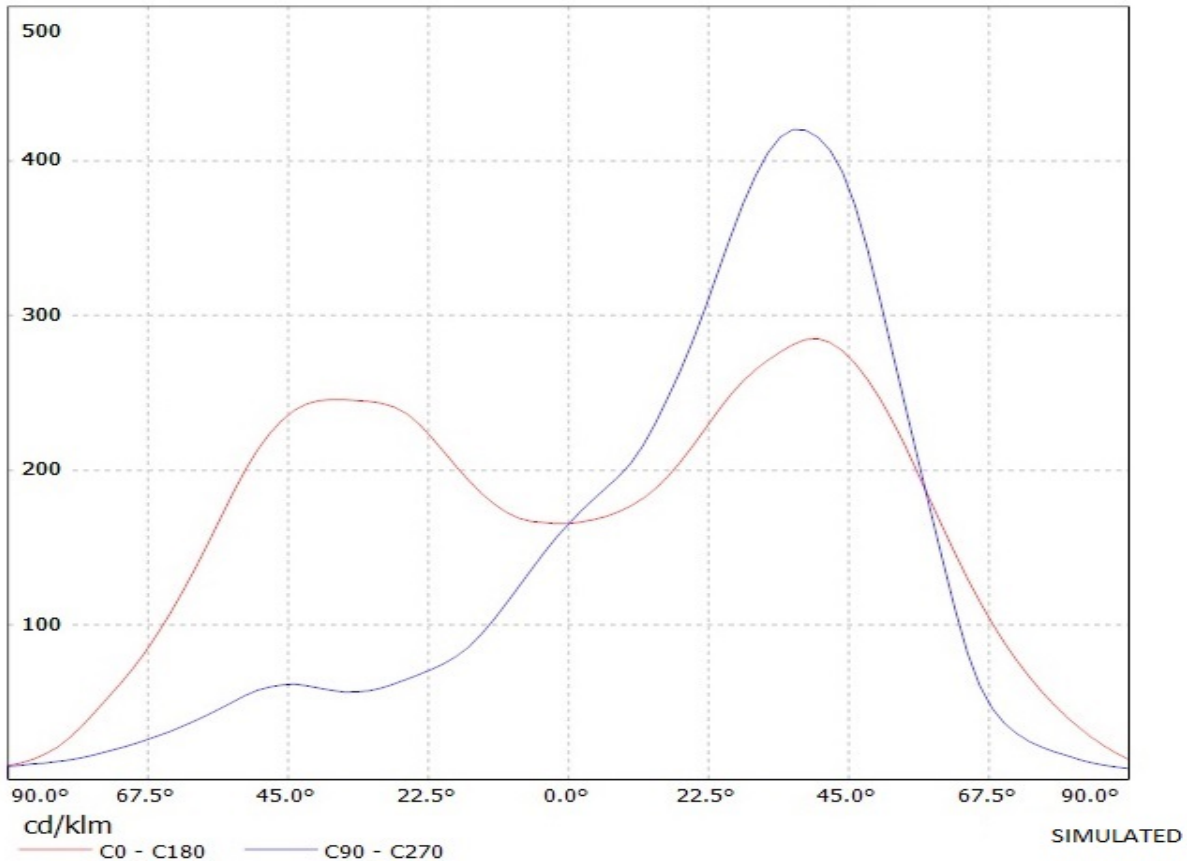

Ledil Oy C11415_Strada-T-DN-XP-G C11415_Strada-T-DN-XP-G / LDC (Linear)

Luminaire: Ledil Oy C11415_Strada-T-DN-XP-G C11415_Strada-T-DN-XP-G
Lamps: 1 x Cree XP-G (White)

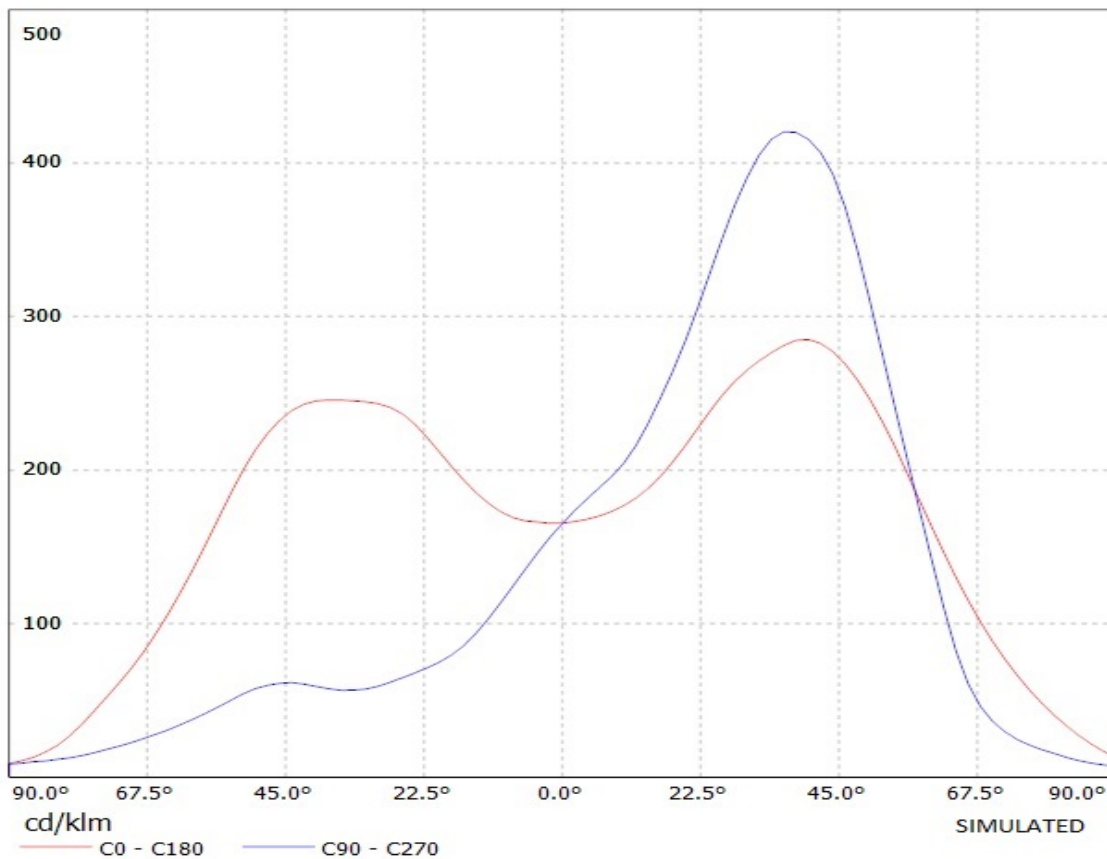

Ledil Oy C11425_Strada-T-DW-XP-G C11425_Strada-T-DW-XP-G / LDC (Linear)

Luminaire: Ledil Oy C11425_Strada-T-DW-XP-G C11425_Strada-T-DW-XP-G
Lamps: 1 x Cree Xp-G (White)

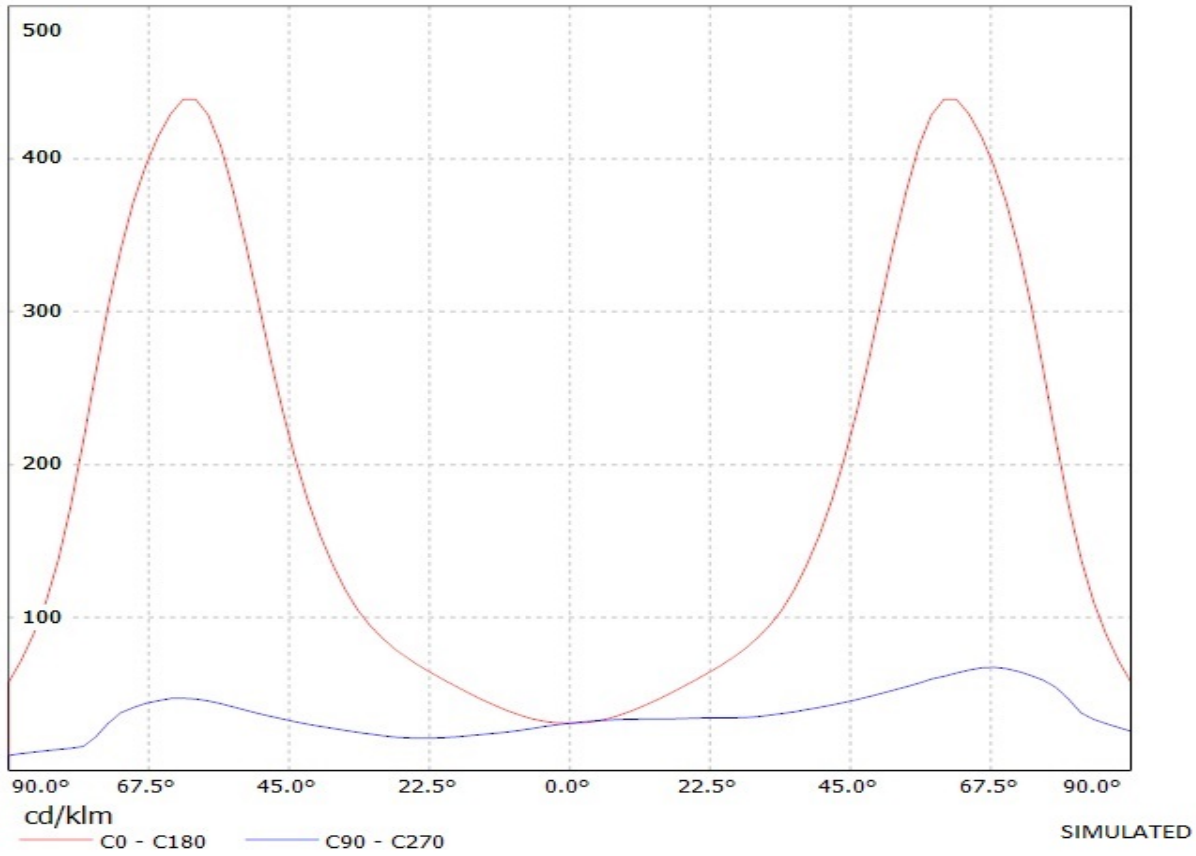

Ledil Oy C11425_Strada-T-DW-XP-G C11425_Strada-T-DW-XP-G / LDC (Linear)

Luminaire: Ledil Oy C11425_Strada-T-DW-XP-G C11425_Strada-T-DW-XP-G
Lamps: 1 x Cree Xp-G (White)

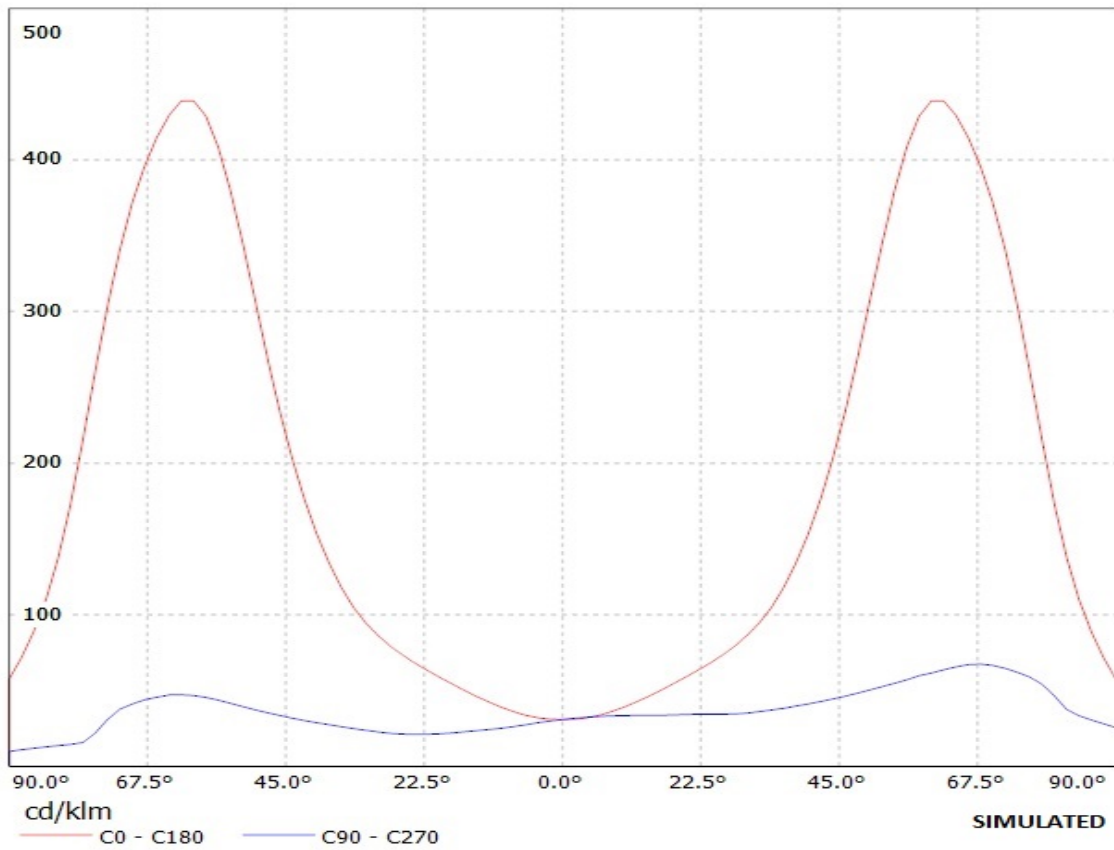

Luminaire: Ledil Oy C12049-Strada-FT-XP-G C12049-Strada-FT-XP-G
Lamps: 1 x Cree XP-G 250mA 89.6lm

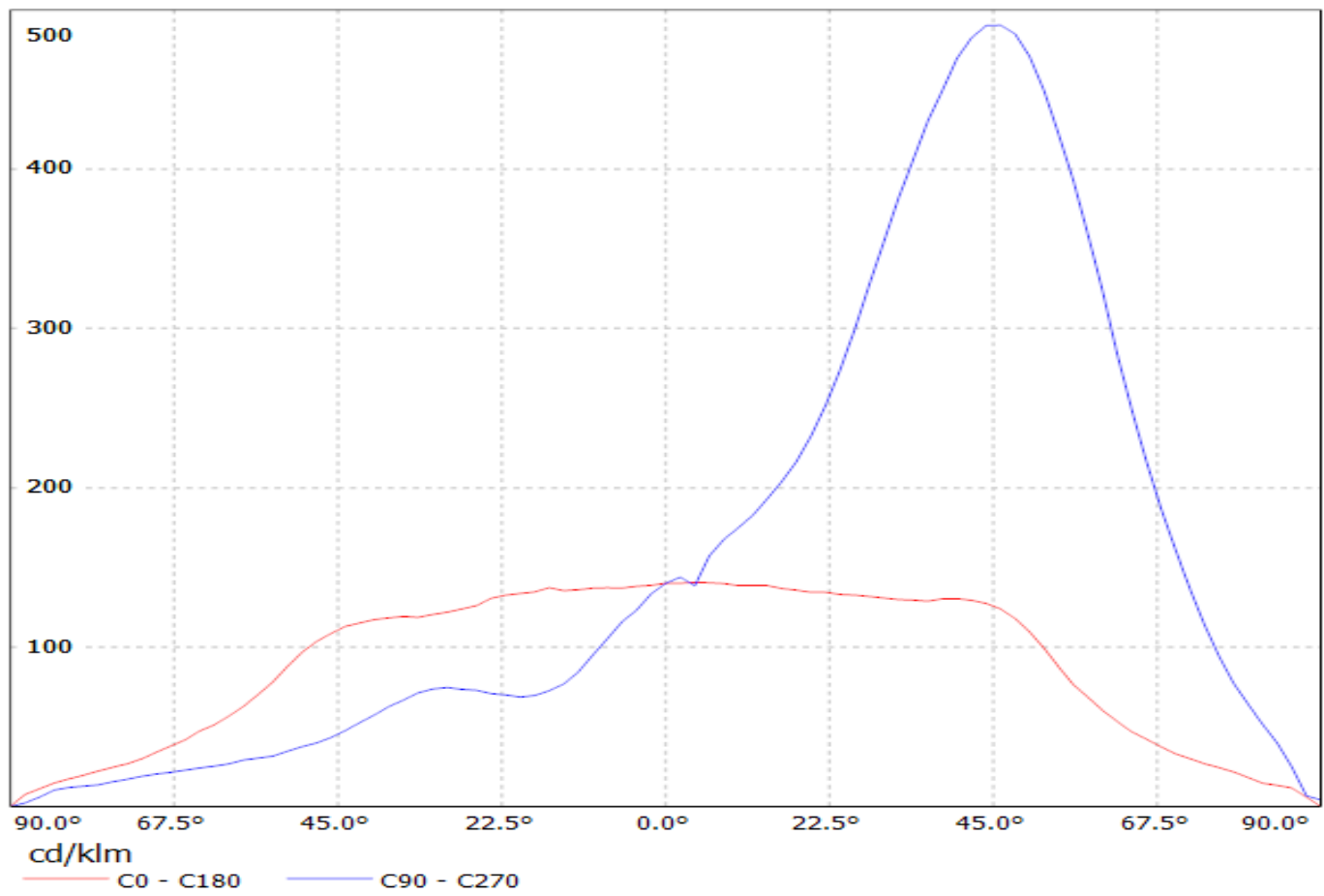

Ledil Oy C12049-Strada-FT-XP-G C12049-Strada-FT-XP-G / LDC (Linear)

Luminaire: Ledil Oy C12049-Strada-FT-XP-G C12049-Strada-FT-XP-G
Lamps: 1 x LED Module

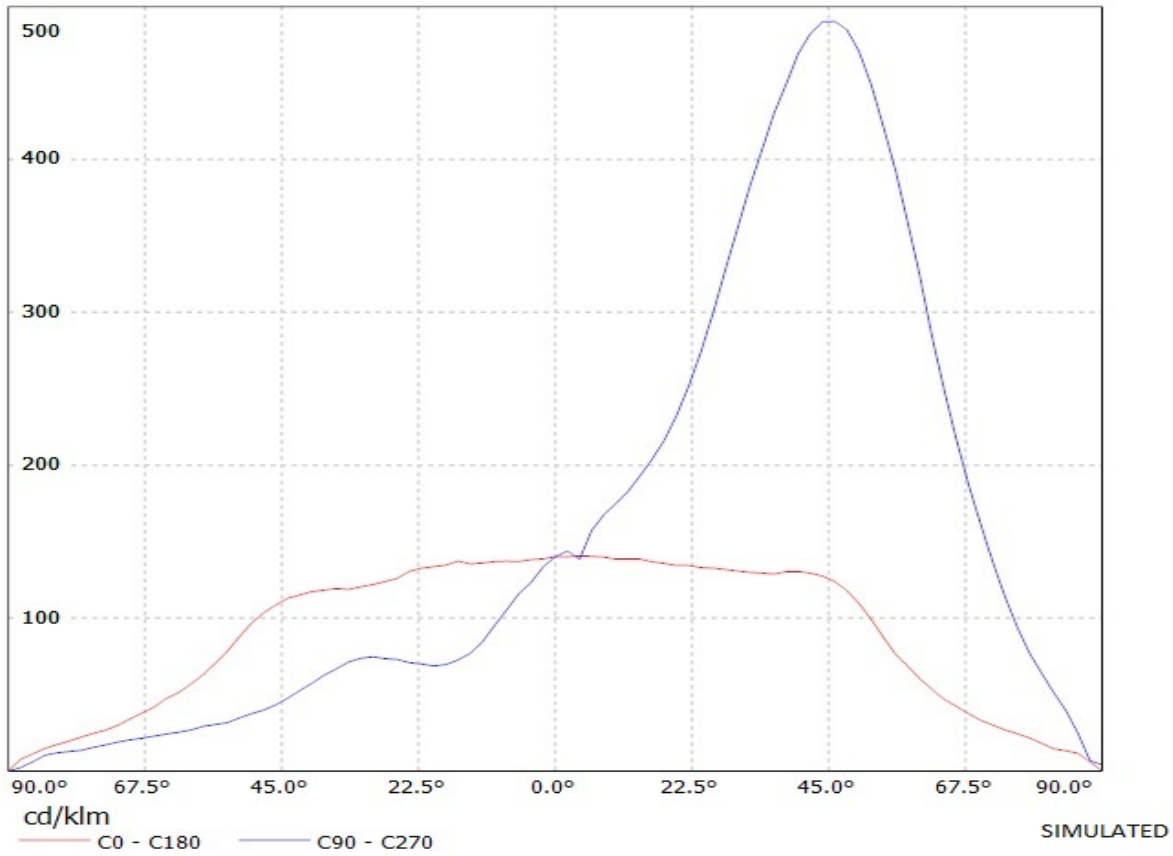

Luminaire: Ledil Oy C12086-Strada-FW-XP-G LOR=92%
Lamps: 1 x Cree XP-G 250mA 87lm

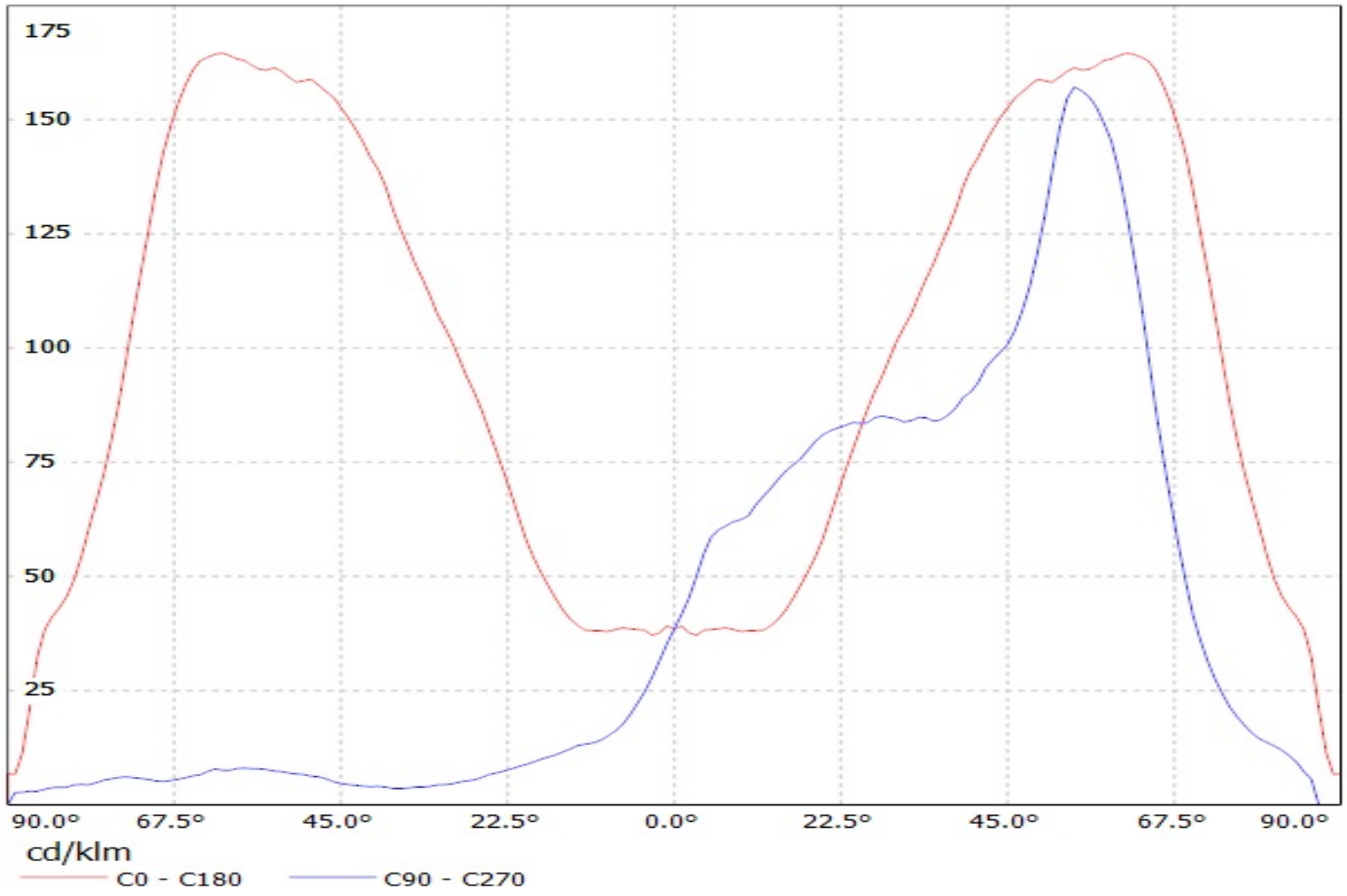

Luminaire: Ledil Oy C10818_Strada-A-XPG C10818_Strada-A-XPG
Lamps: 1 x Cree XP-G (White)

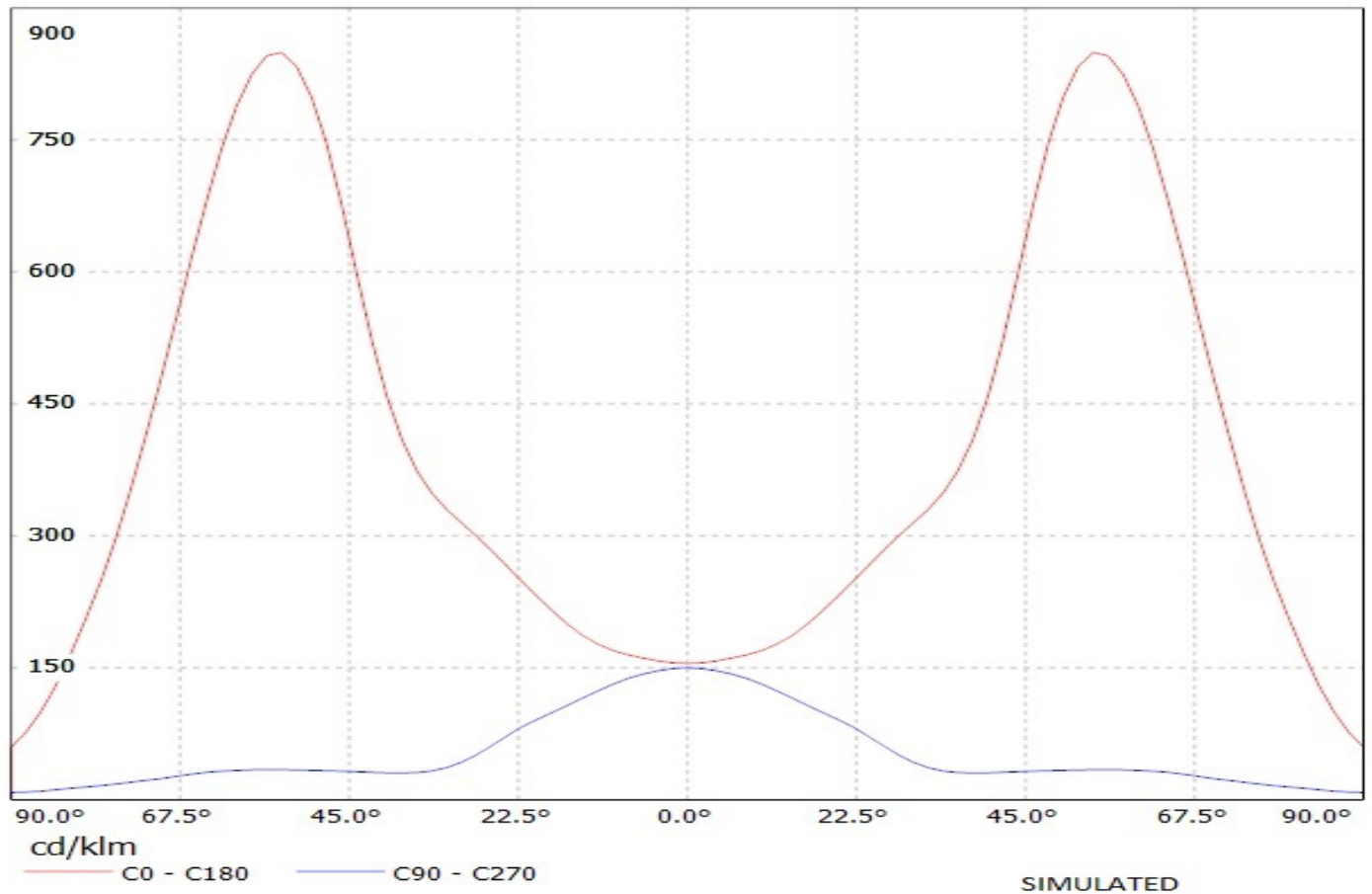

Luminaire: Ledil Oy CA10823_Strada-A-XPG CA10823_Strada-A-XPG
Lamps: 1 x Cree XP-G (White)

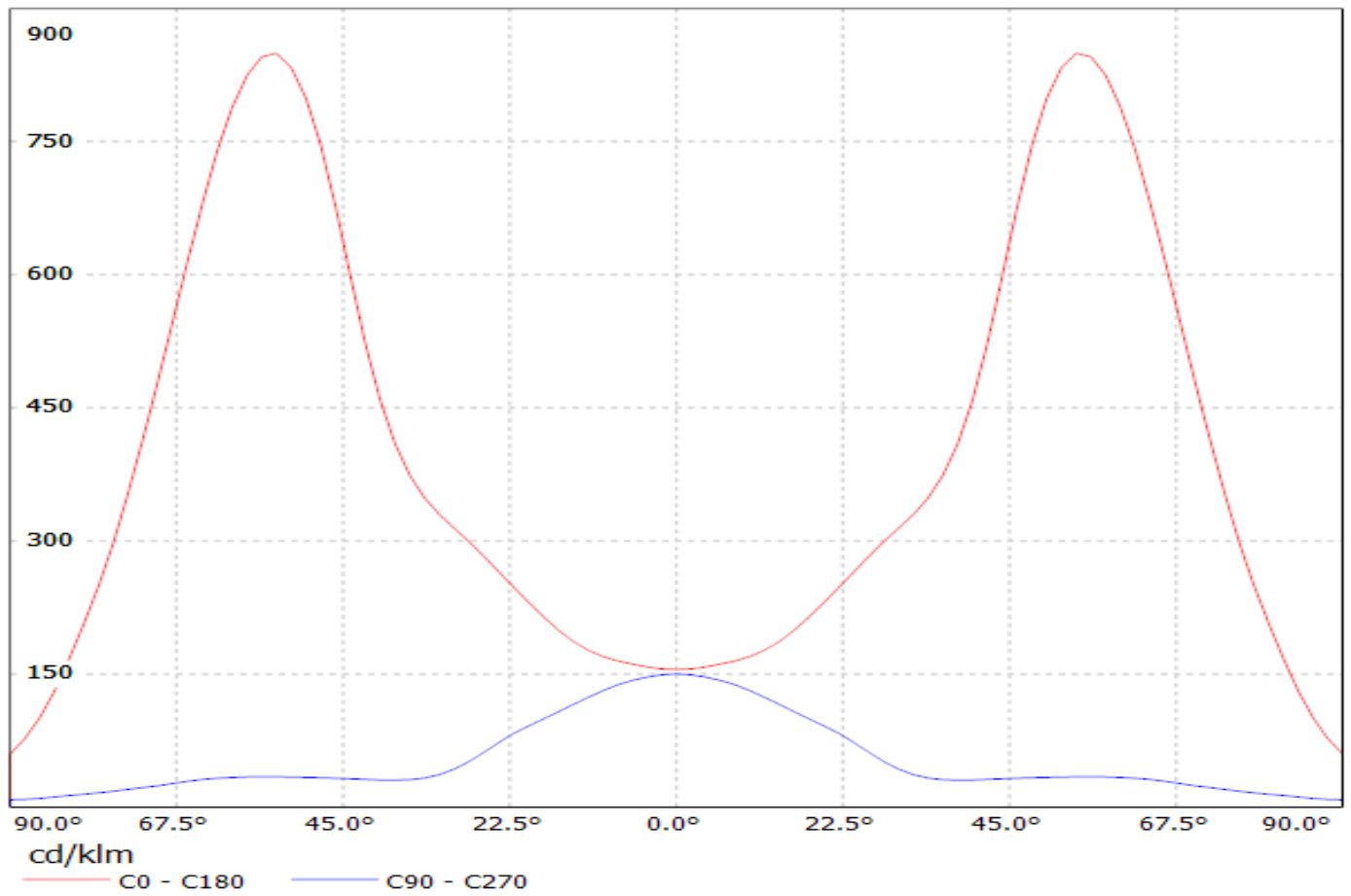

Ledil Oy C11255_Strada-DW-XP-G C11255_Strada-DW-XP-G / LDC (Linear)

Luminaire: Ledil Oy C11255_Strada-DW-XP-G C11255_Strada-DW-XP-G
Lamps: 1 x Cree XP-G (White)

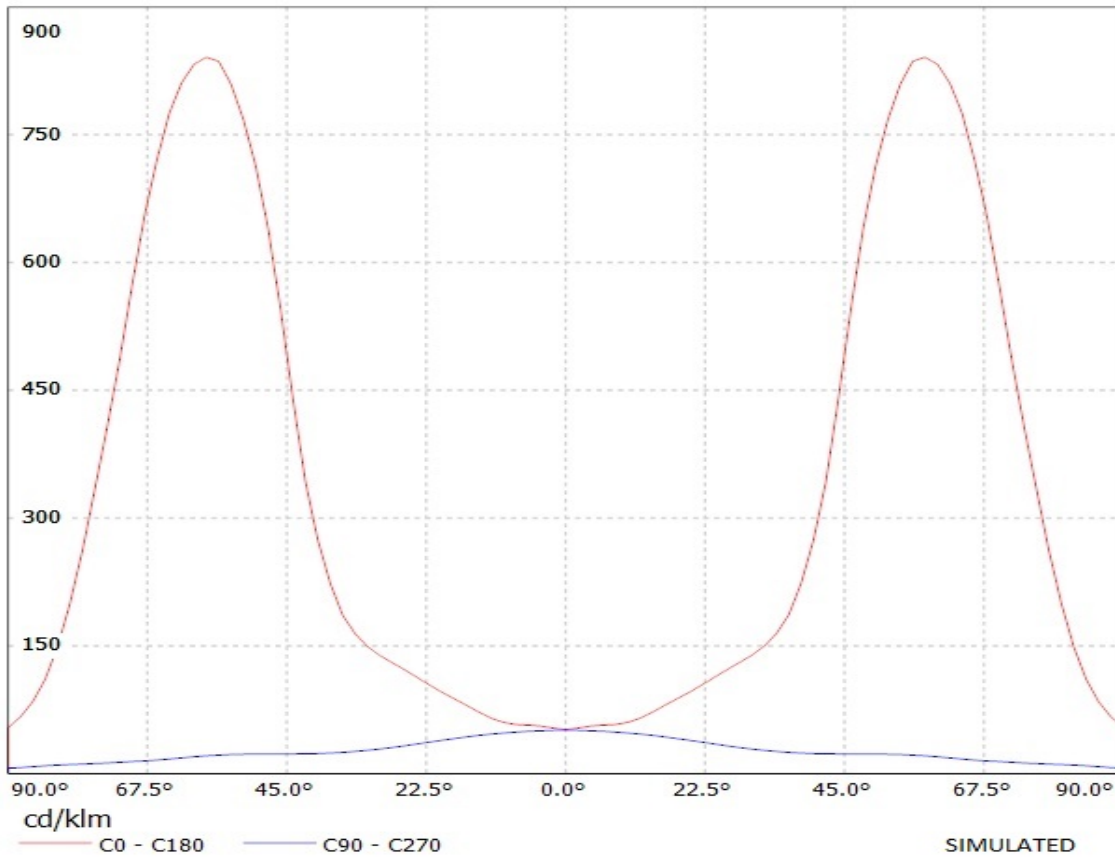

Ledil Oy C11255_Strada-DW-XP-G C11255_Strada-DW-XP-G / LDC (Linear)

Luminaire: Ledil Oy C11255_Strada-DW-XP-G C11255_Strada-DW-XP-G
Lamps: 1 x Cree XP-G (White)

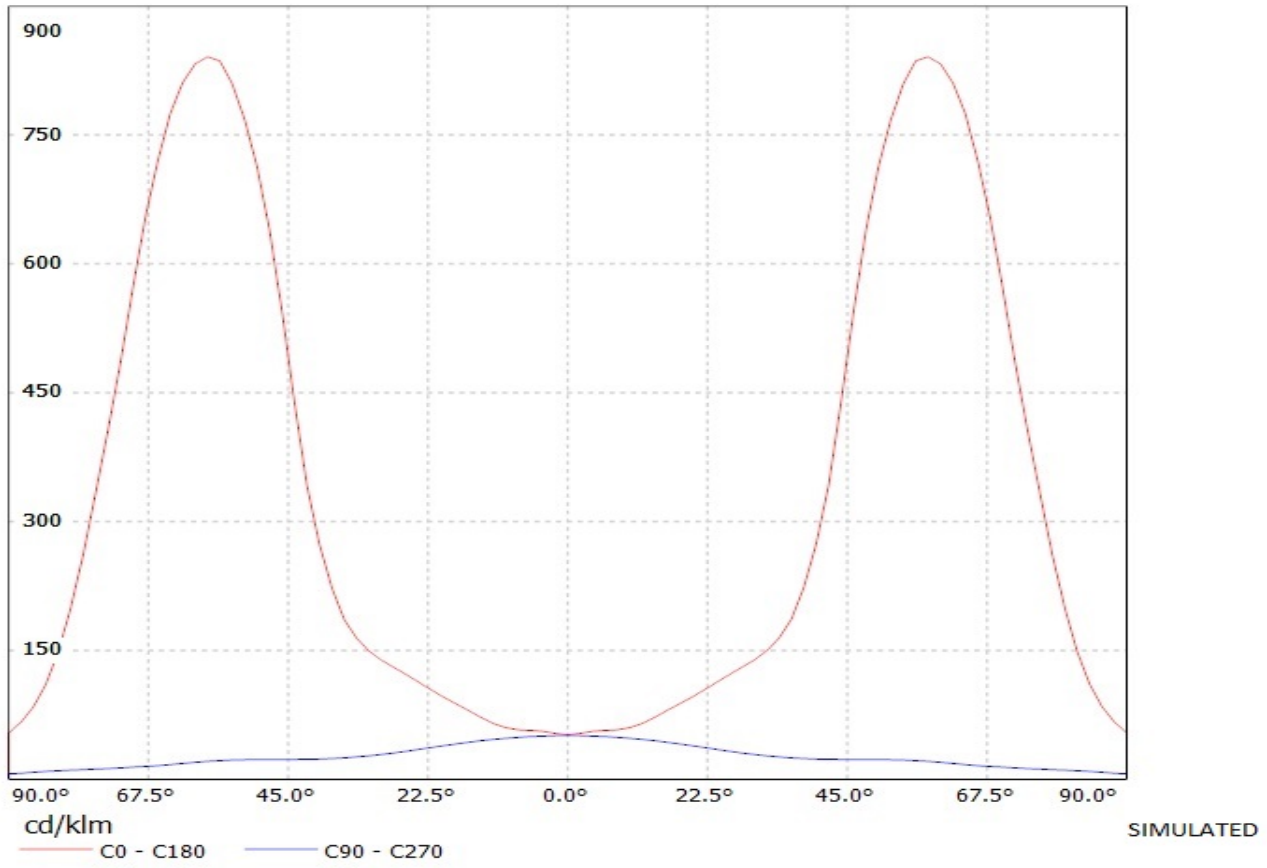

Ledil Oy C10926_Strada-B-XPG C10926_Strada-B-XPG / LDC (Linear)

Luminaire: Ledil Oy C10926_Strada-B-XPG C10926_Strada-B-XPG
Lamps: 1 x Cree XP-G (White)

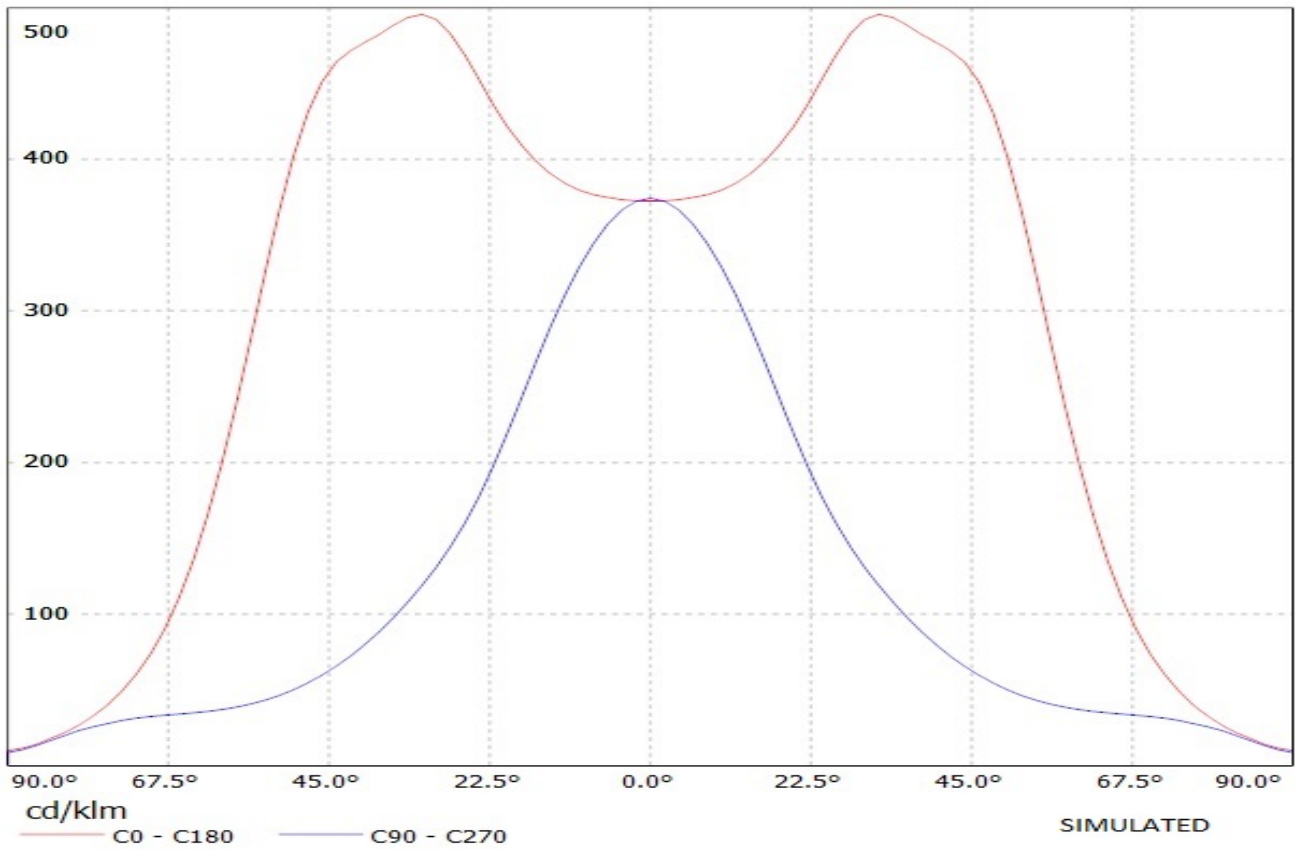

Ledil Oy C10926_Strada-B-XPG C10926_Strada-B-XPG / LDC (Linear)

Luminaire: Ledil Oy C10926_Strada-B-XPG C10926_Strada-B-XPG
Lamps: 1 x Cree XP-G (White)

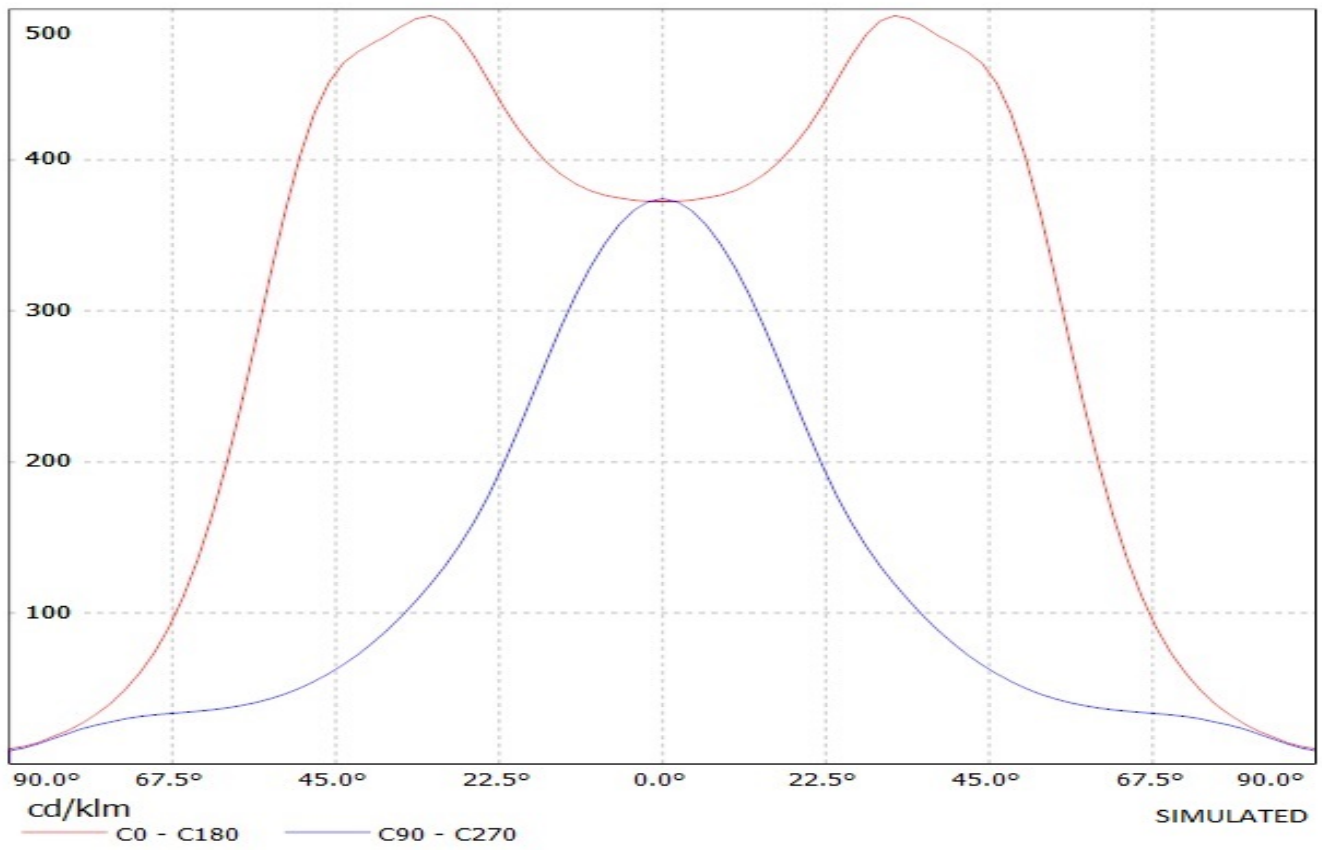

Ledil Oy C11252_Strada-C2-XP-G C11252_Strada-C2-XP-G / LDC (Linear)

Luminaire: Ledil Oy C11252_Strada-C2-XP-G C11252_Strada-C2-XP-G
Lamps: 1 x Cree XP-G (White)

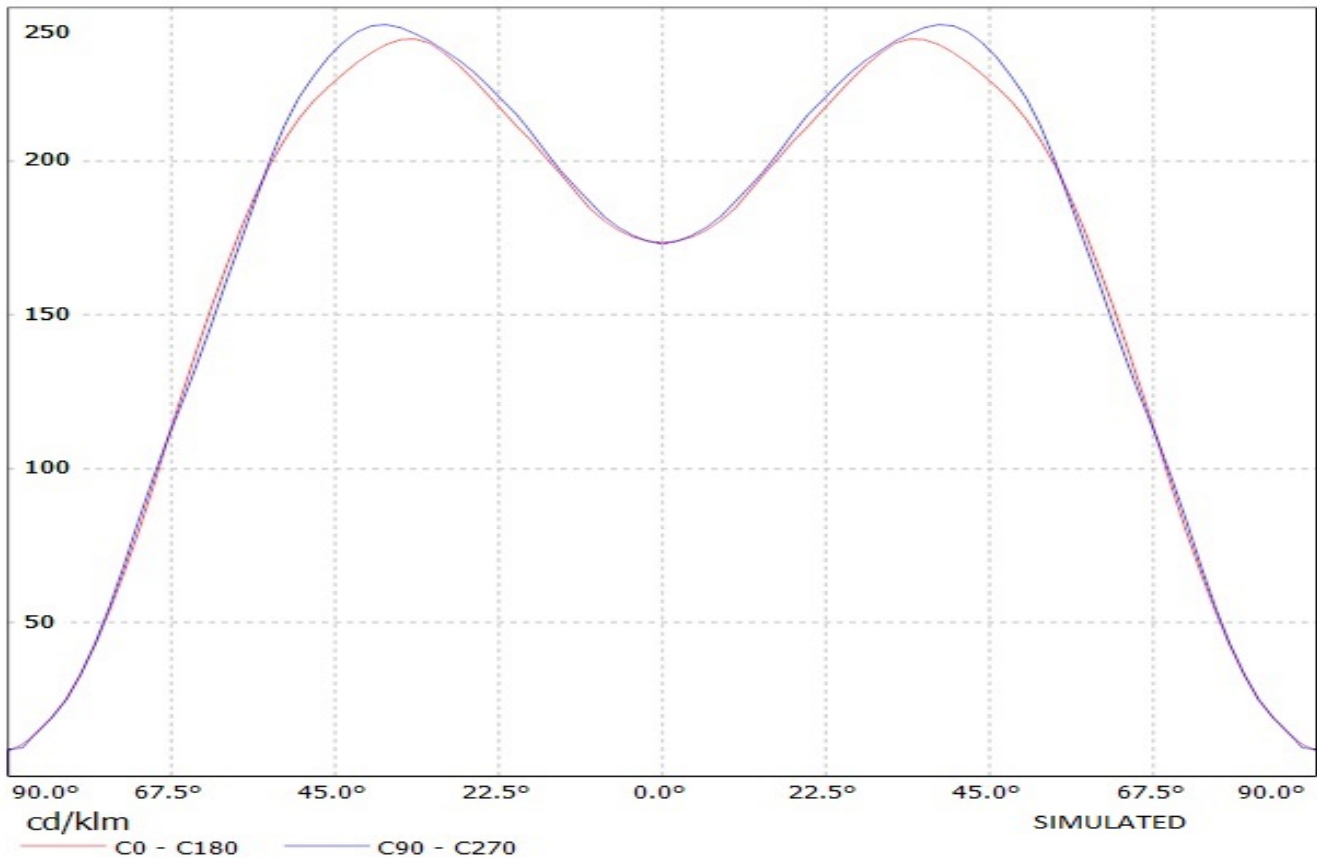

Ledil Oy C11249_Strada-S-XP-G C11249_Strada-S-XP-G / LDC (Linear)

Luminaire: Ledil Oy C11249_Strada-S-XP-G C11249_Strada-S-XP-G
Lamps: 1 x Cree XP-G (White)

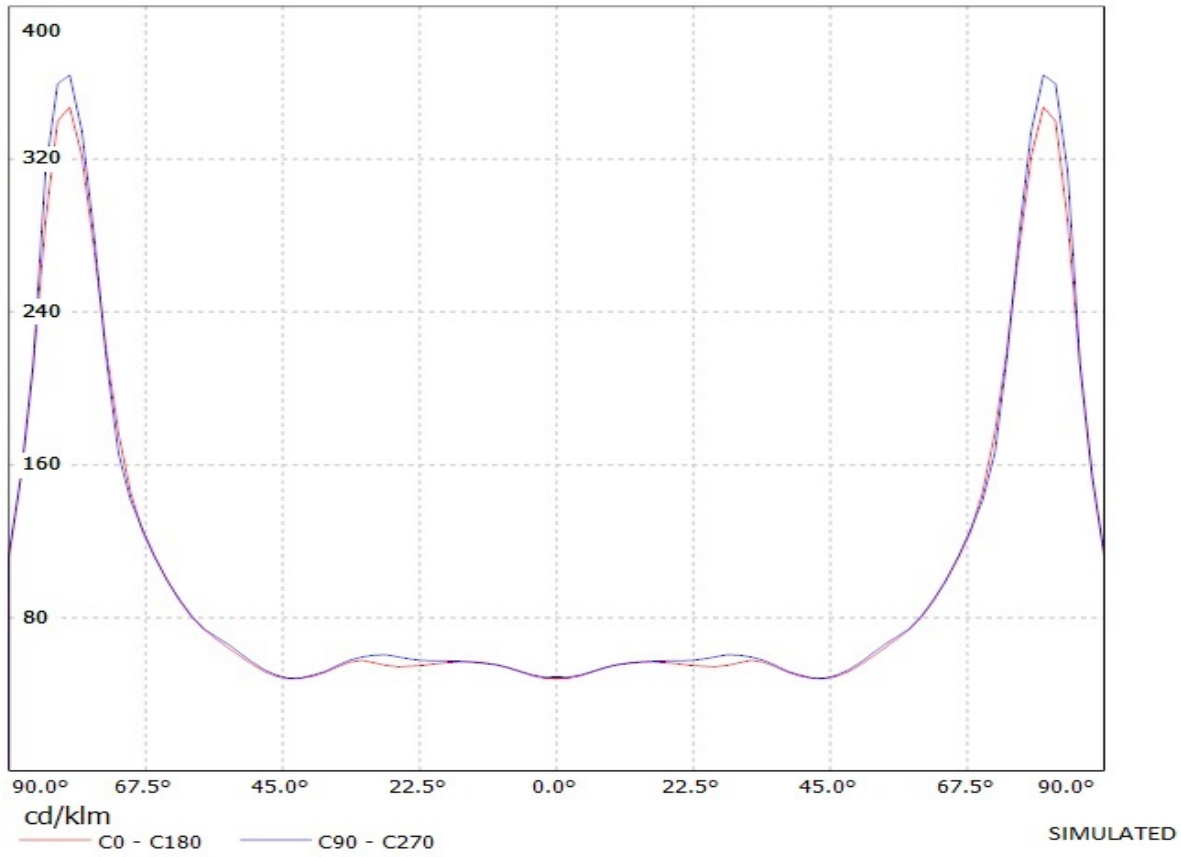

Ledil Oy C11249_Strada-S-XP-G C11249_Strada-S-XP-G / LDC (Linear)

Luminaire: Ledil Oy C11249_Strada-S-XP-G C11249_Strada-S-XP-G
Lamps: 1 x Cree XP-G (White)

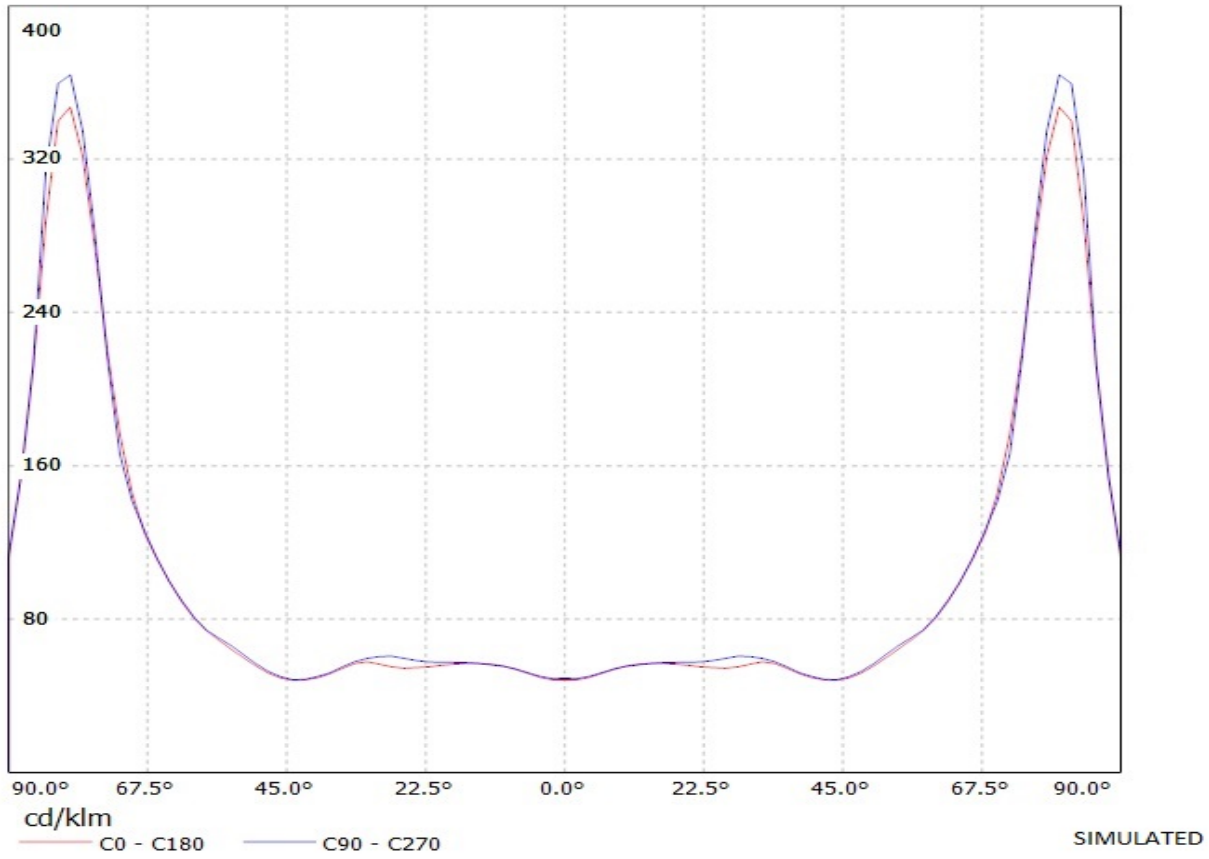

Ledil Oy C11415_Strada-T-DN-XP-G C11415_Strada-T-DN-XP-G / LDC (Polar)

Luminaire: Ledil Oy C11415_Strada-T-DN-XP-G C11415_Strada-T-DN-XP-G

Lamps: 1 x Cree XP-G (White)

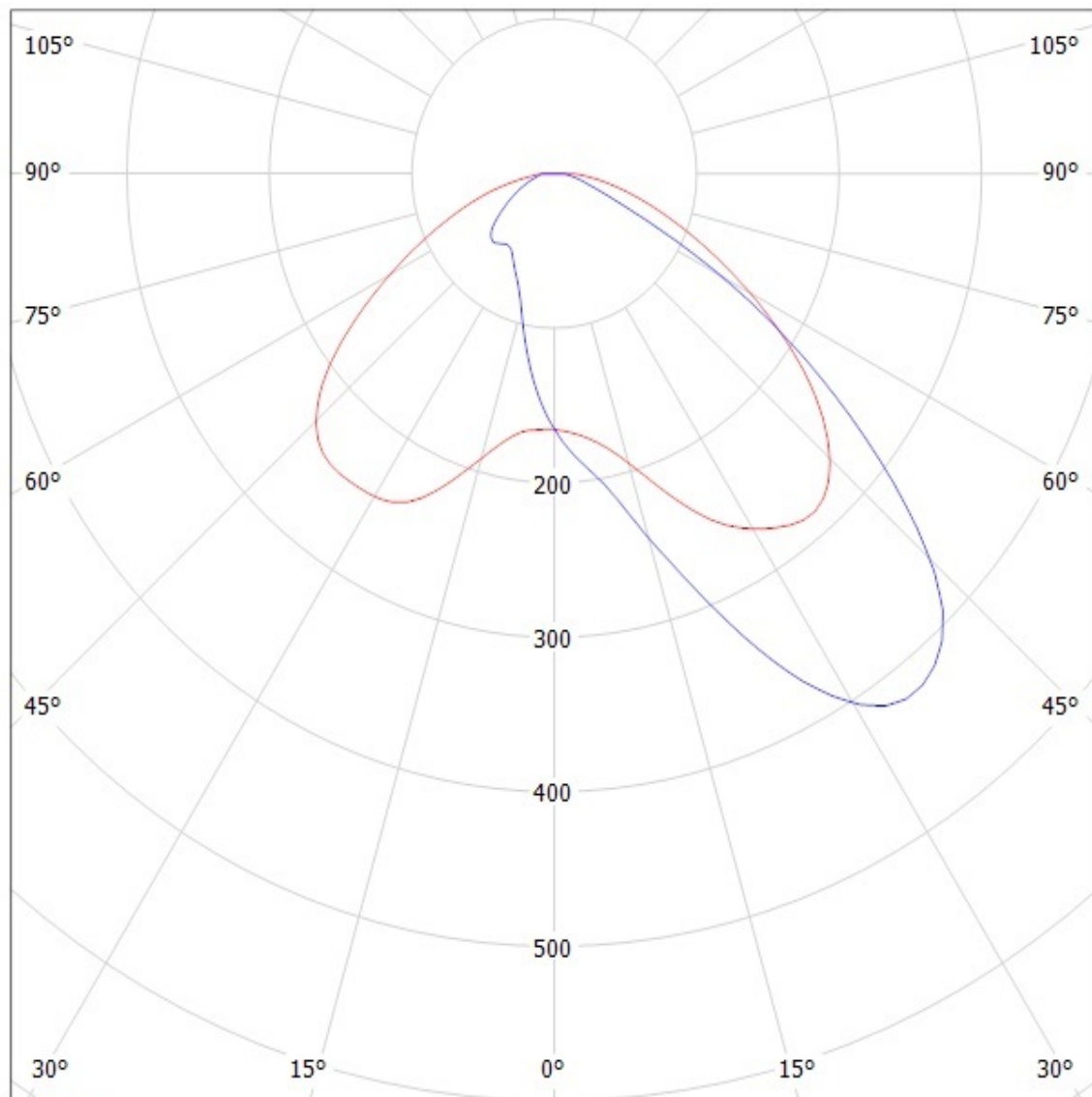

cd/klm

— C0 - C180

— C90 - C270

SIMULATED

Ledil Oy C11415_Strada-T-DN-XP-G C11415_Strada-T-DN-XP-G / LDC (Polar)

Luminaire: Ledil Oy C11415_Strada-T-DN-XP-G C11415_Strada-T-DN-XP-G

Lamps: 1 x Cree XP-G (White)

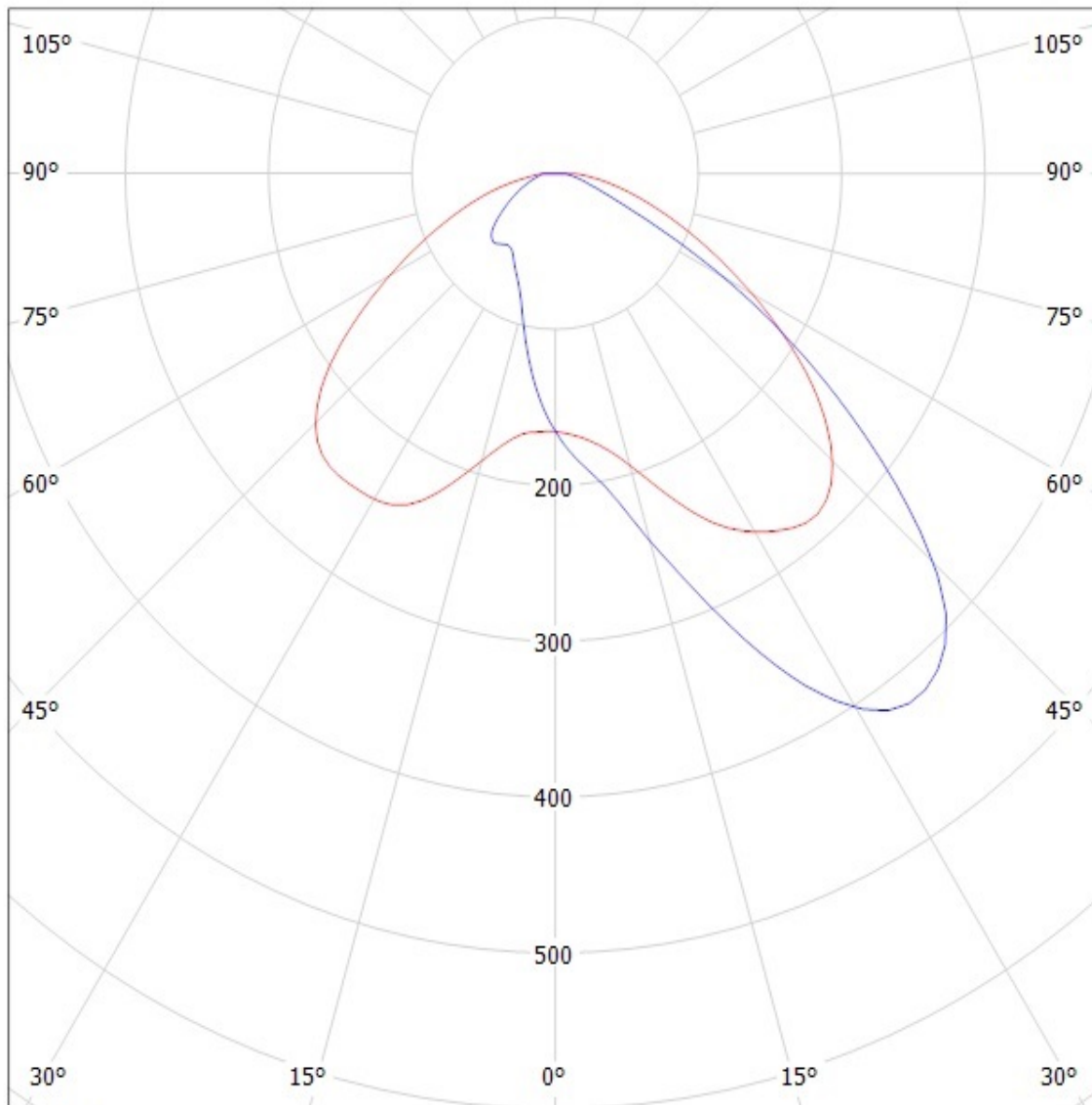

cd/klm

— C0 - C180 — C90 - C270

SIMULATED

Ledil Oy C11425_Strada-T-DW-XP-G C11425_Strada-T-DW-XP-G / LDC (Polar)

Luminaire: Ledil Oy C11425_Strada-T-DW-XP-G C11425_Strada-T-DW-XP-G

Lamps: 1 x Cree Xp-G (White)

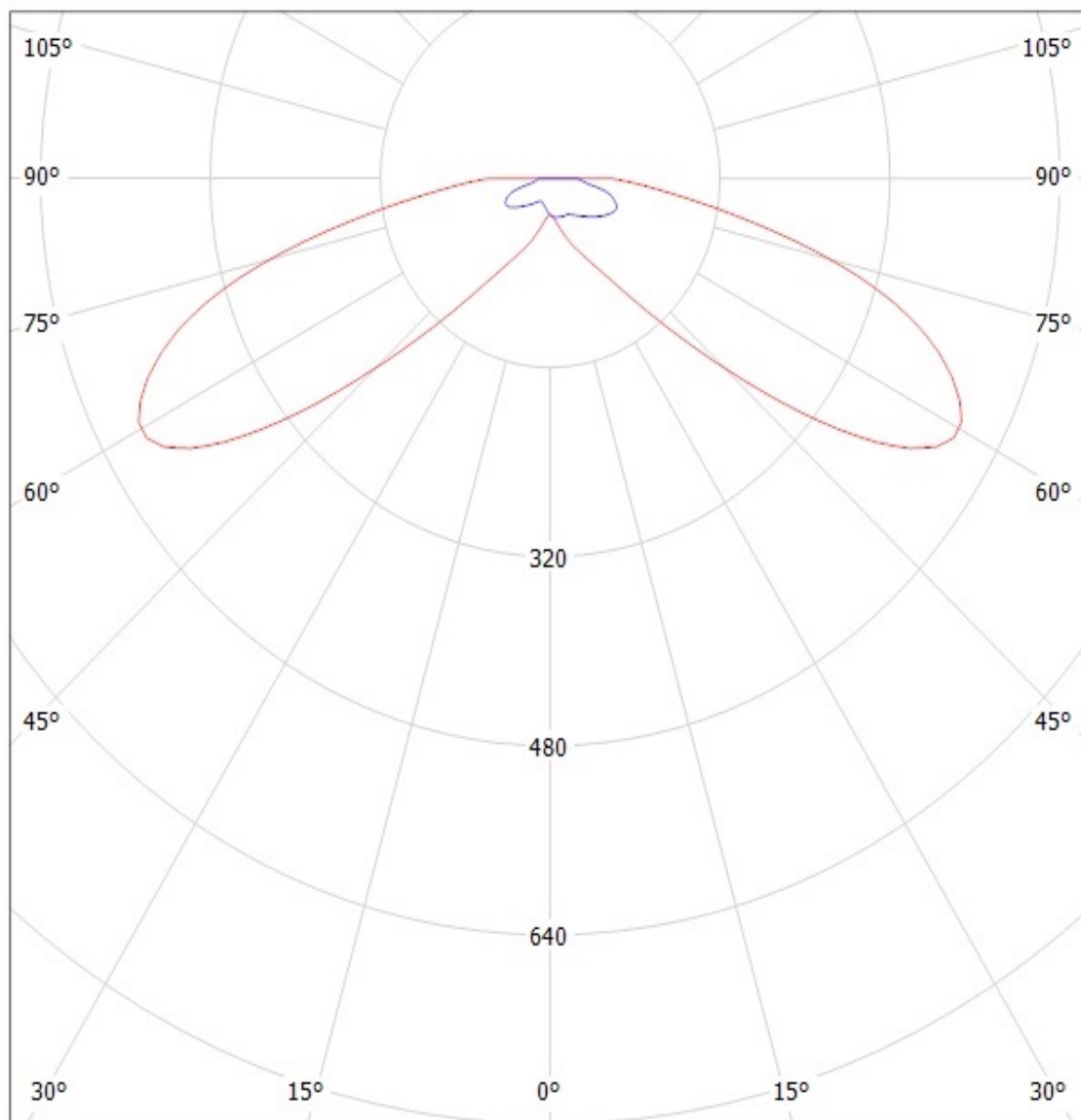

cd/klm

— C0 - C180

— C90 - C270

SIMULATED

Ledil Oy C11425_Strada-T-DW-XP-G C11425_Strada-T-DW-XP-G / LDC (Polar)

Luminaire: Ledil Oy C11425_Strada-T-DW-XP-G C11425_Strada-T-DW-XP-G
Lamps: 1 x Cree Xp-G (White)

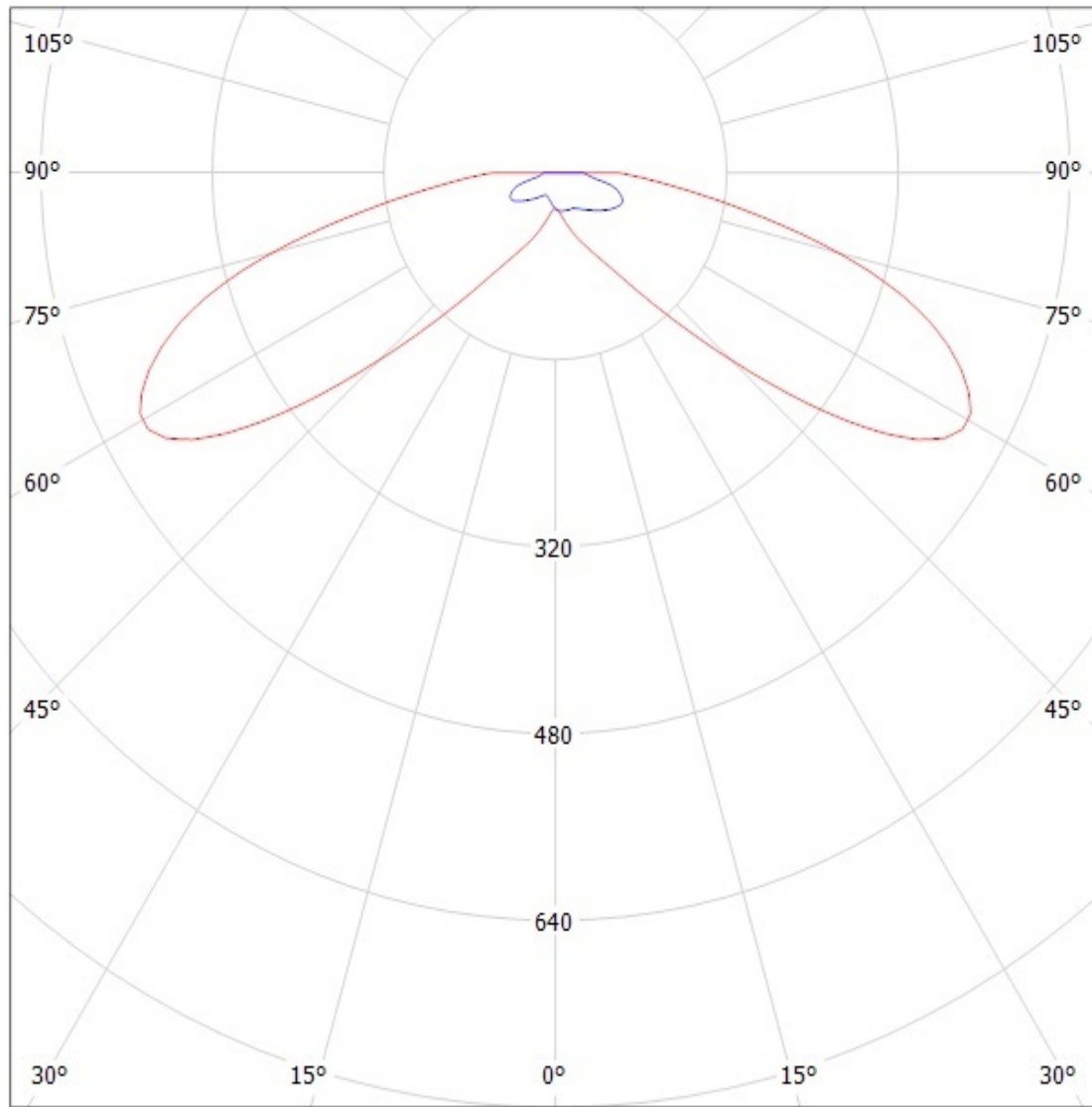

cd/klm

— C0 - C180 — C90 - C270

SIMULATED

Luminaire: Ledli Oy C12049-Strada-FT-XP-G C12049-Strada-FT-XP-G
Lamps: 1 x Cree XP-G 250mA 83.6lm

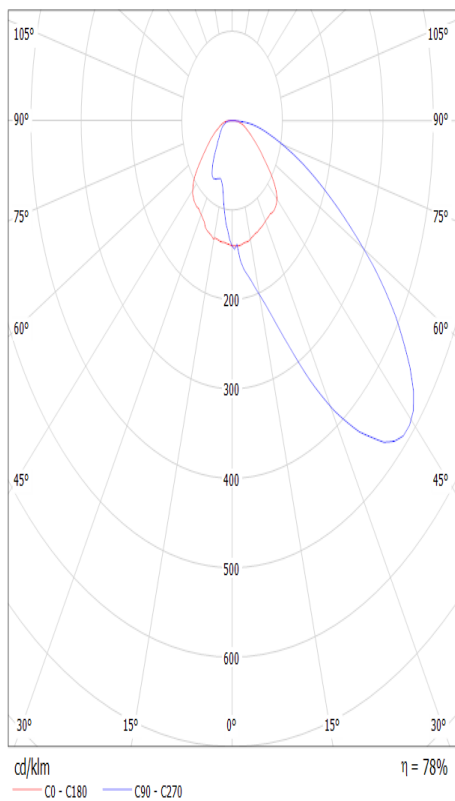

Ledil Oy C12049-Strada-FT-XP-G C12049-Strada-FT-XP-G / LDC (Polar)

Luminaire: Ledil Oy C12049-Strada-FT-XP-G C12049-Strada-FT-XP-G

Lamps: 1 x LED Module

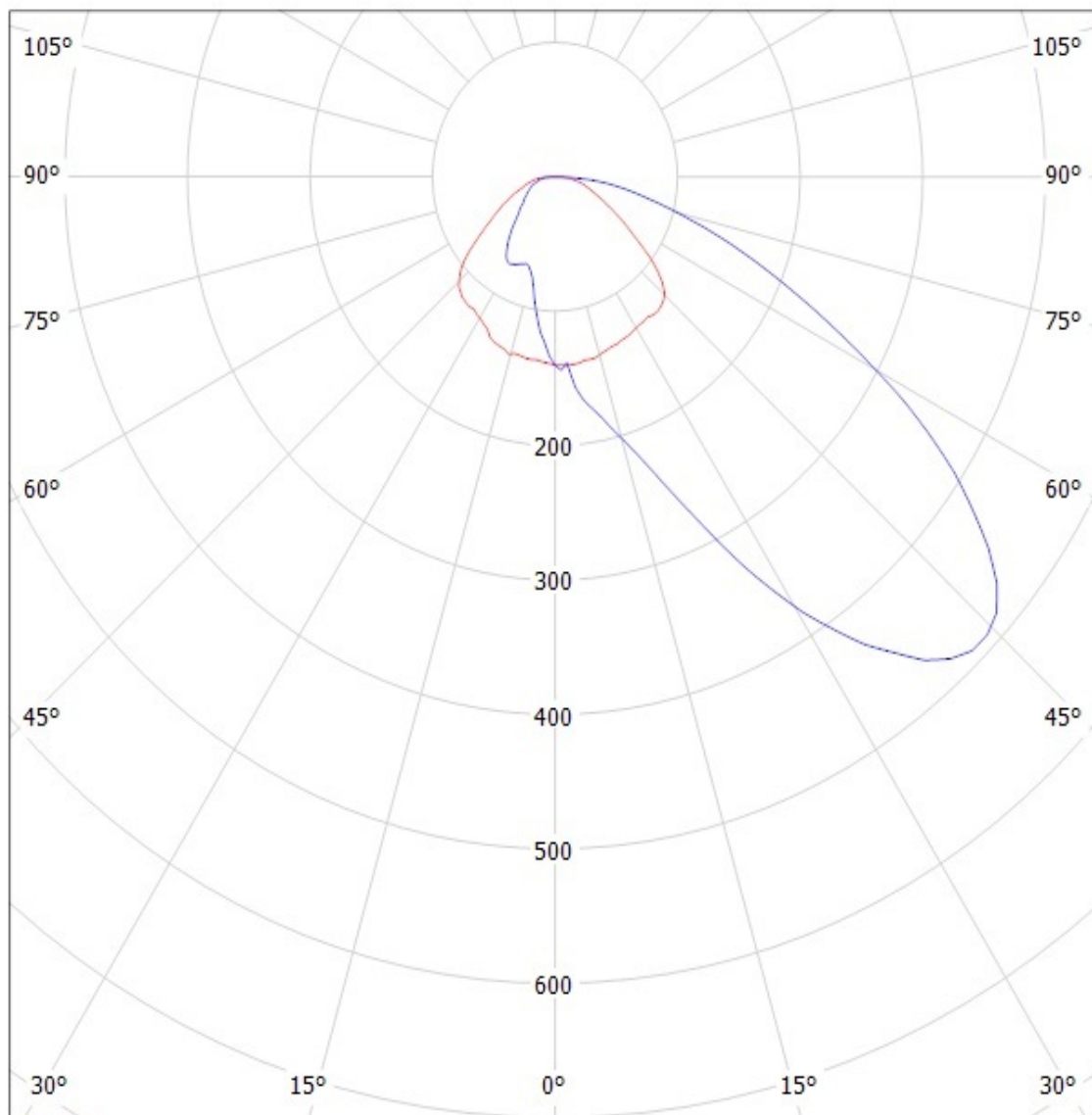

cd/klm

— C0 - C180

— C90 - C270

SIMULATED

Luminaire: Ledil Oy C12086-Strada-FW-XP-G LOR=92%
Lamps: 1 x Cree XP-G 250mA 87lm

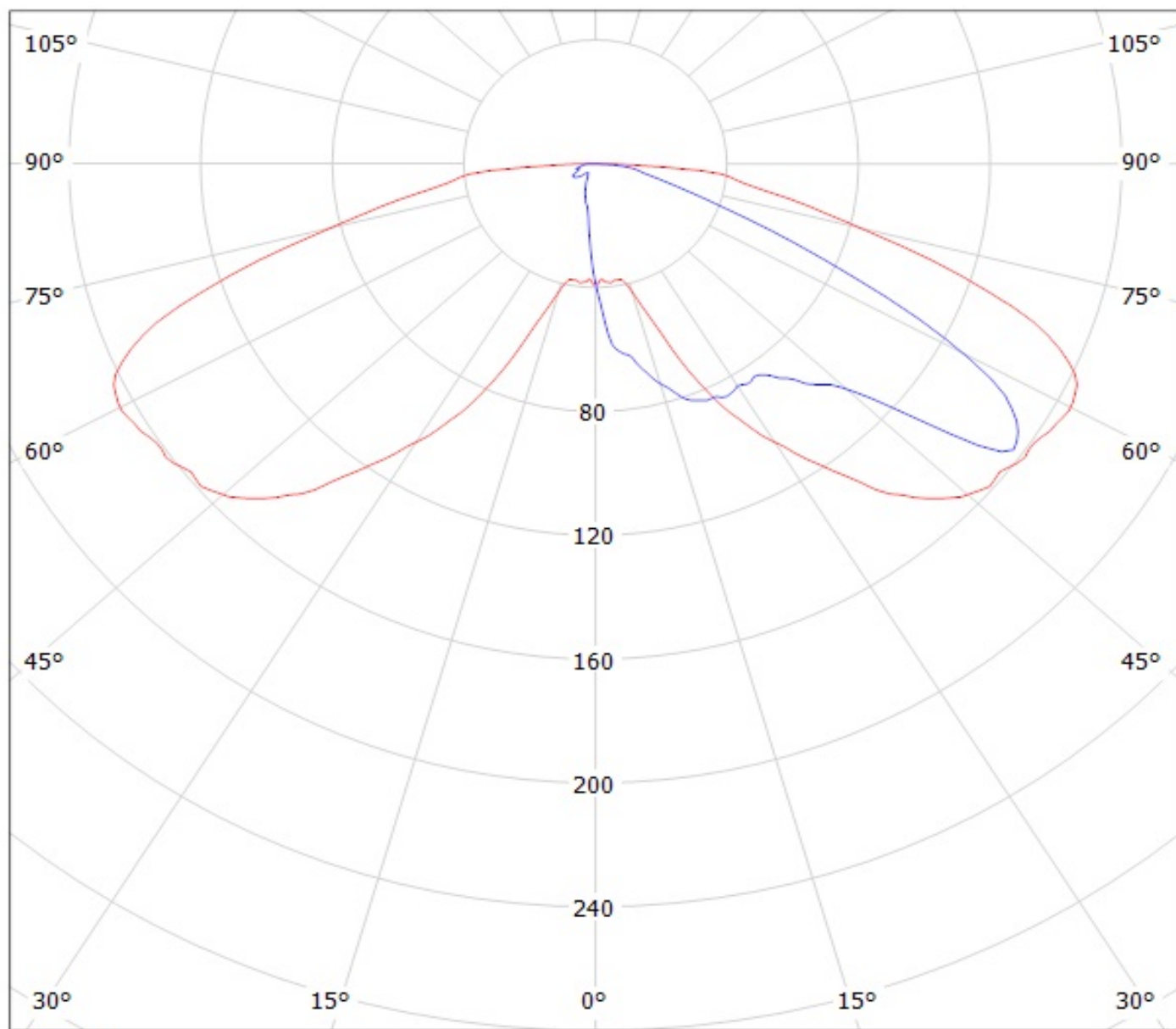

cd/klm

— C0 - C180

— C90 - C270

Luminaire: Ledil Oy C10818_Strada-A-XPG C10818_Strada-A-XPG
Lamps: 1 x Cree XP-G (White)

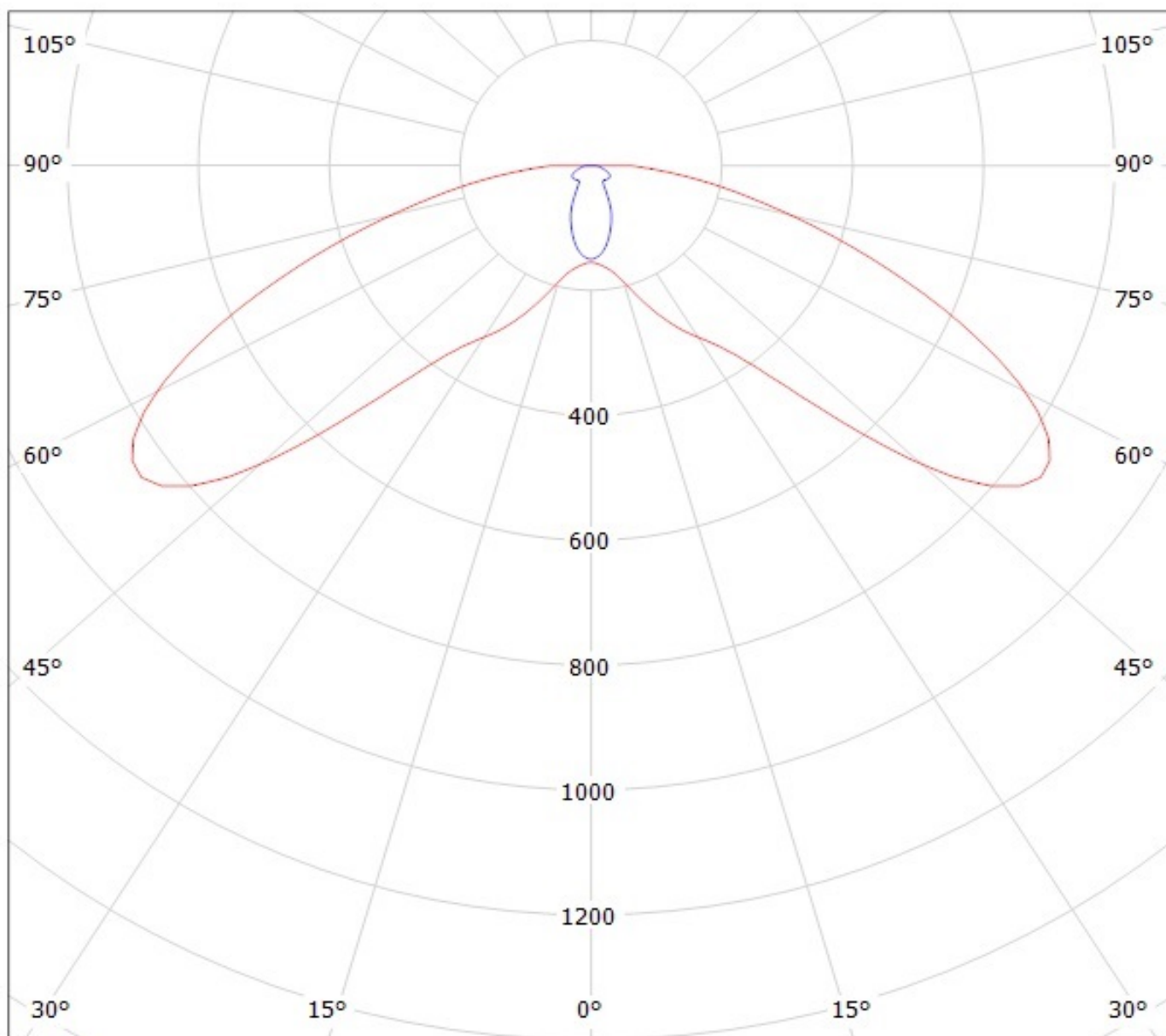

cd/klm

— C0 - C180

— C90 - C270

SIMULATED

$\eta = 82\%$

Luminaire: Ledil Oy CA10823_Strada-A-XPG CA10823_Strada-A-XPG
Lamps: 1 x Cree XP-G (White)

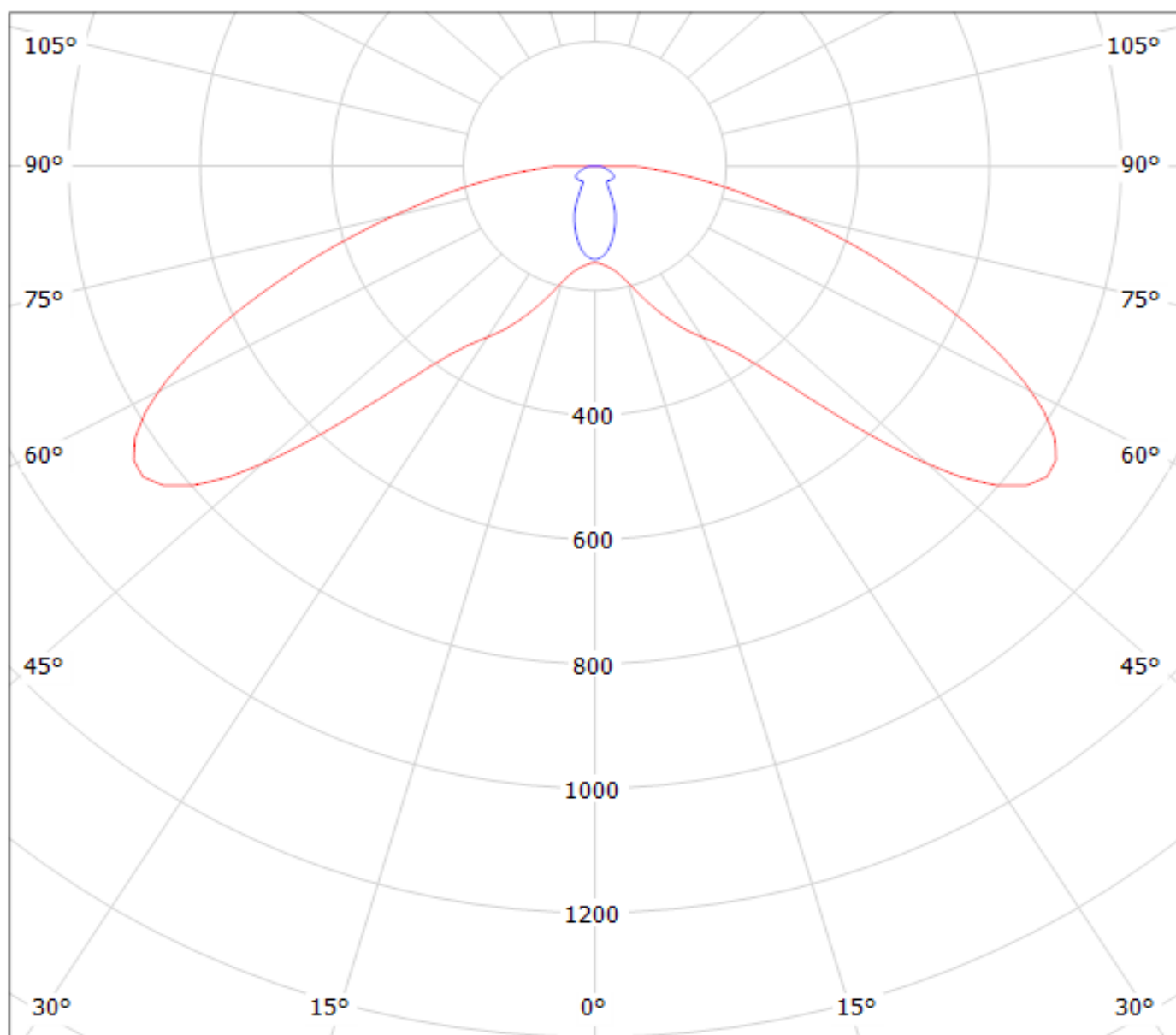

cd/klm

— C0 - C180

— C90 - C270

Ledil Oy C11255_Strada-DW-XP-G C11255_Strada-DW-XP-G / LDC (Polar)

Luminaire: Ledil Oy C11255_Strada-DW-XP-G C11255_Strada-DW-XP-G

Lamps: 1 x Cree XP-G (White)

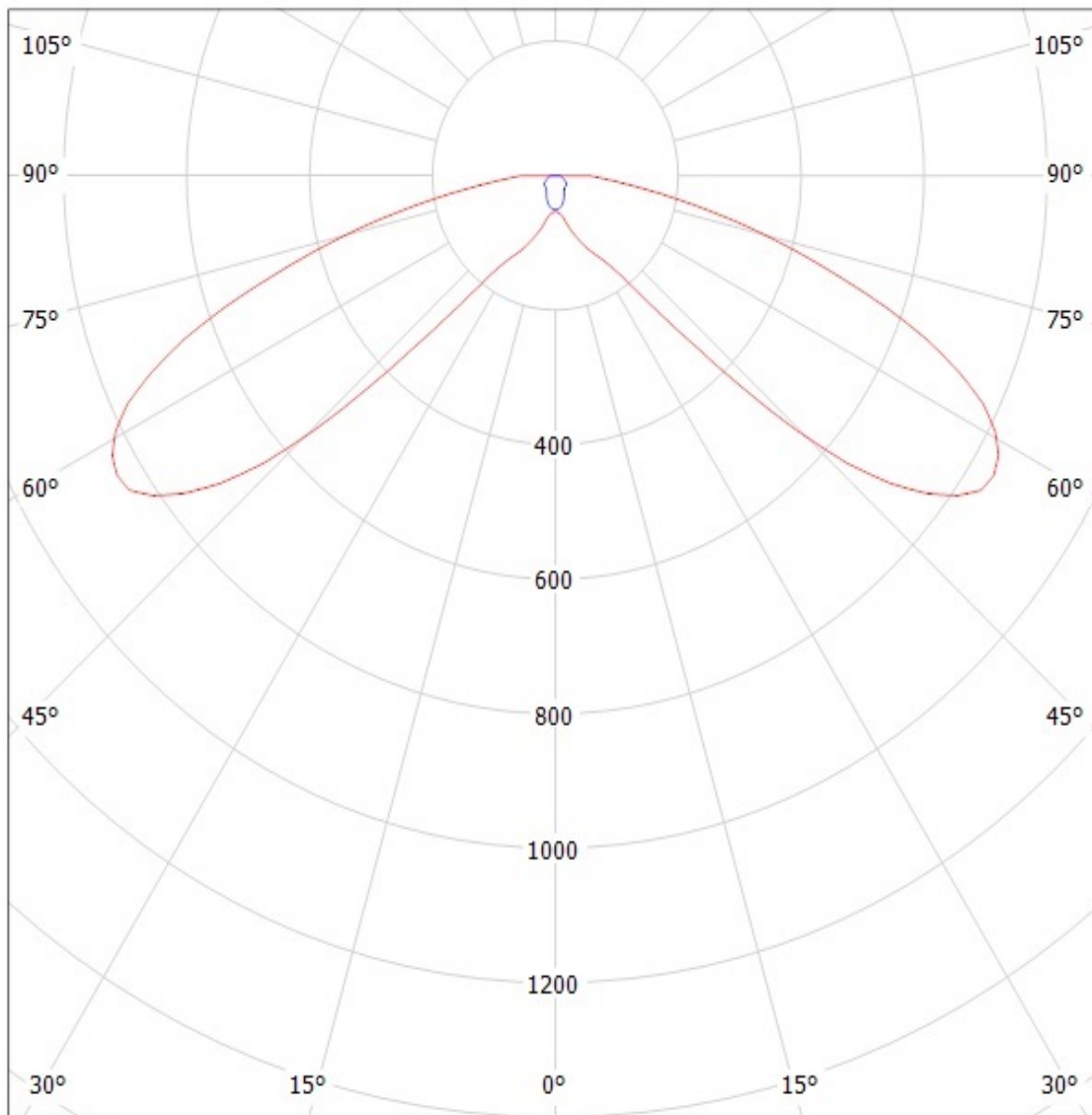

cd/klm

SIMULATED

— C0 - C180 — C90 - C270

Ledil Oy C11255_Strada-DW-XP-G C11255_Strada-DW-XP-G / LDC (Polar)

Luminaire: Ledil Oy C11255_Strada-DW-XP-G C11255_Strada-DW-XP-G

Lamps: 1 x Cree XP-G (White)

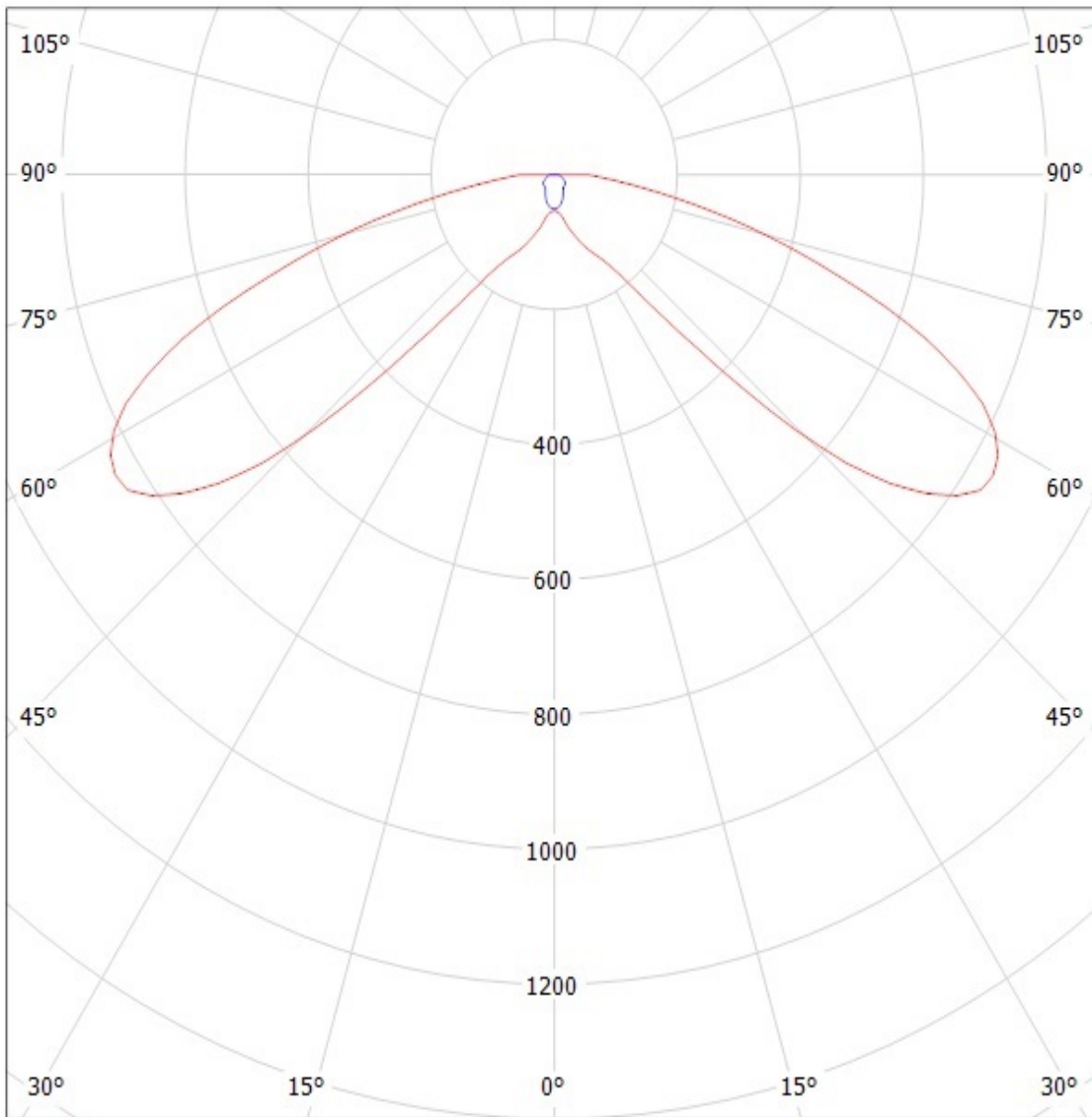

cd/klm

— C0 - C180

— C90 - C270

SIMULATED

Ledil Oy C10926_Strada-B-XPG C10926_Strada-B-XPG / LDC (Polar)

Luminaire: Ledil Oy C10926_Strada-B-XPG C10926_Strada-B-XPG

Lamps: 1 x Cree XP-G (White)

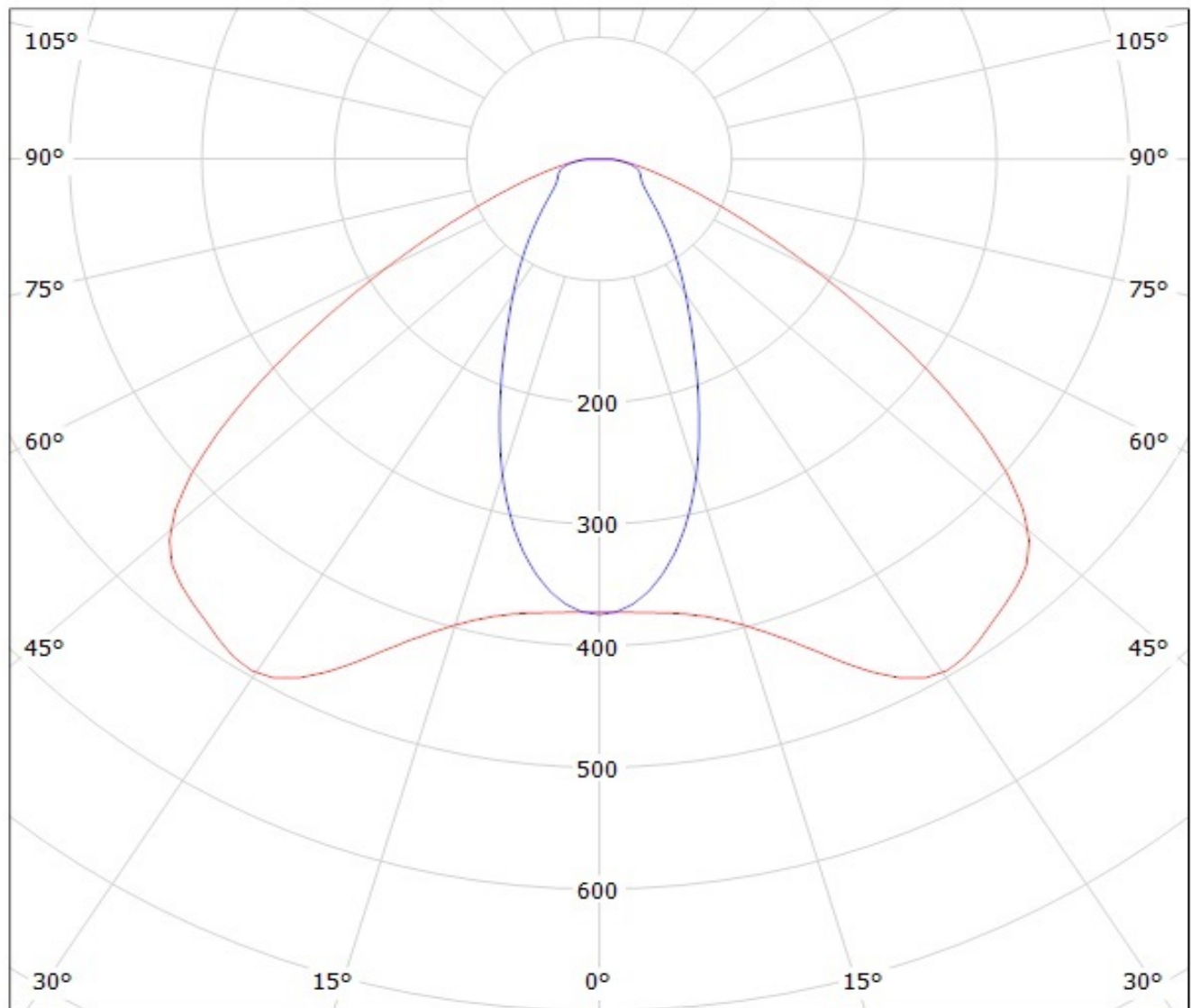

cd/klm

— C0 - C180

— C90 - C270

SIMULATED

Ledil Oy C10926_Strada-B-XPG C10926_Strada-B-XPG / LDC (Polar)

Luminaire: Ledil Oy C10926_Strada-B-XPG C10926_Strada-B-XPG
Lamps: 1 x Cree XP-G (White)

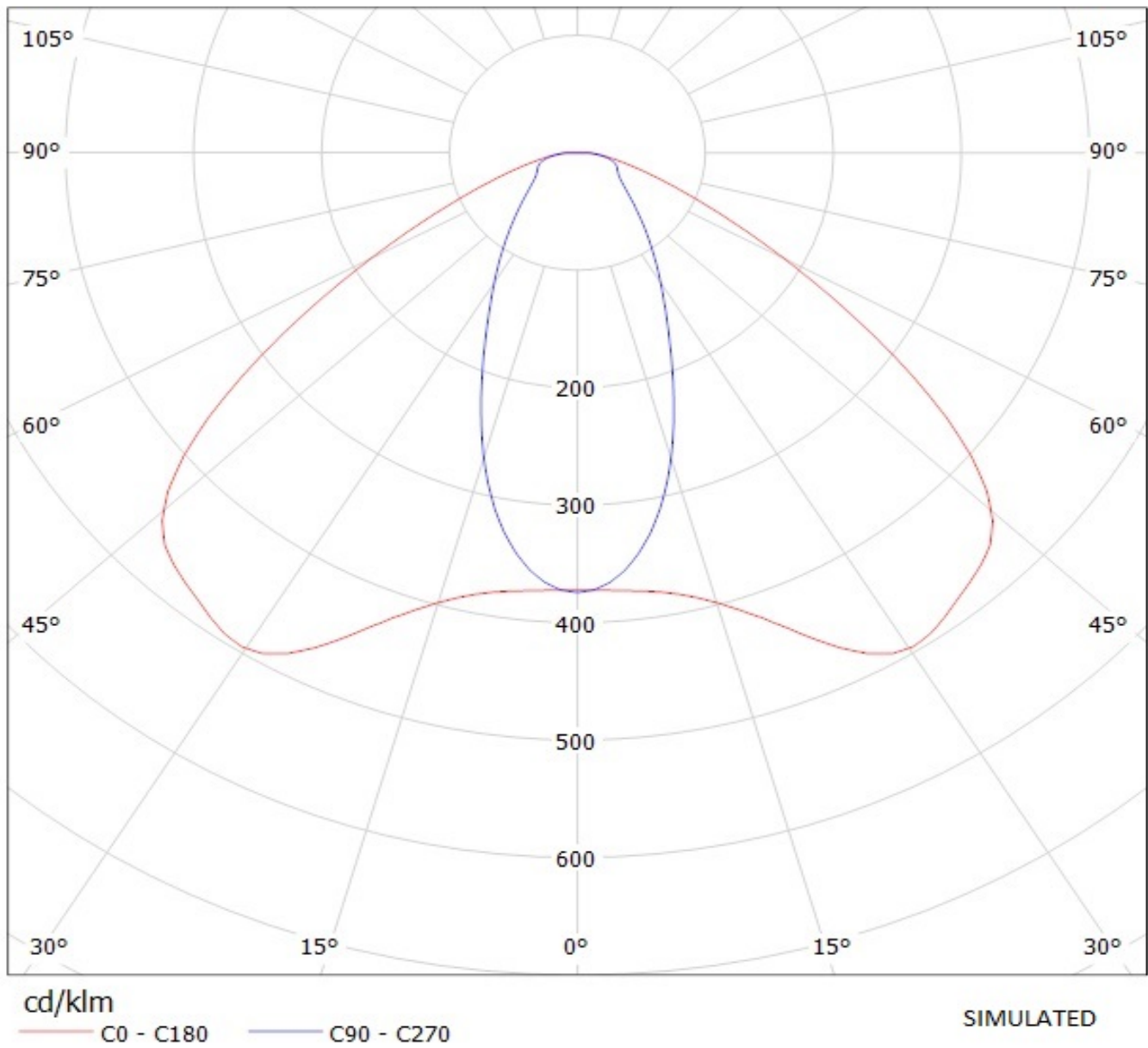

Ledil Oy C11252_Strada-C2-XP-G C11252_Strada-C2-XP-G / LDC (Polar)

Luminaire: Ledil Oy C11252_Strada-C2-XP-G C11252_Strada-C2-XP-G

Lamps: 1 x Cree XP-G (White)

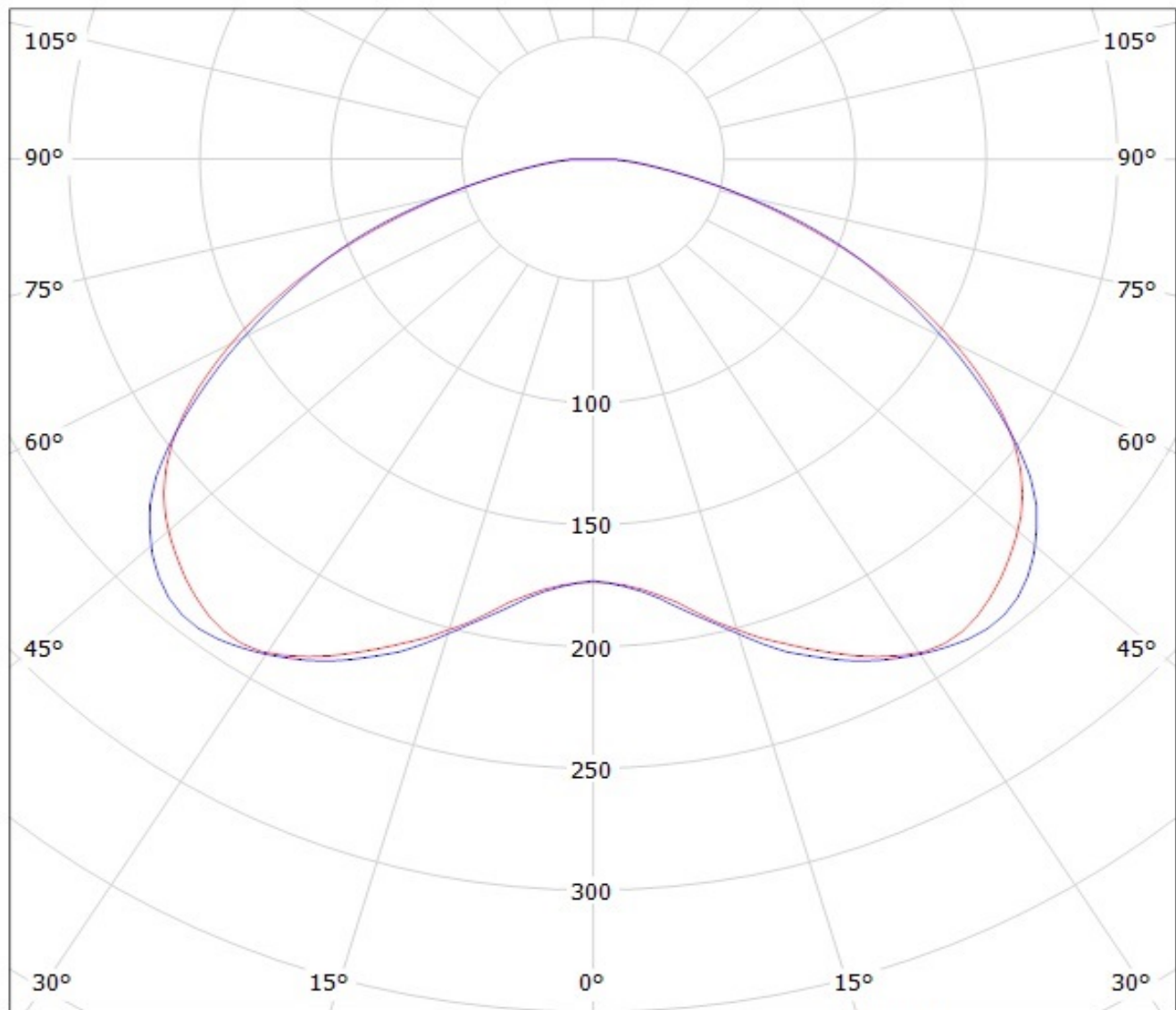

cd/klm

— C0 - C180

— C90 - C270

Ledil Oy C11249_Strada-S-XP-G C11249_Strada-S-XP-G / LDC (Polar)

Luminaire: Ledil Oy C11249_Strada-S-XP-G C11249_Strada-S-XP-G

Lamps: 1 x Cree XP-G (White)

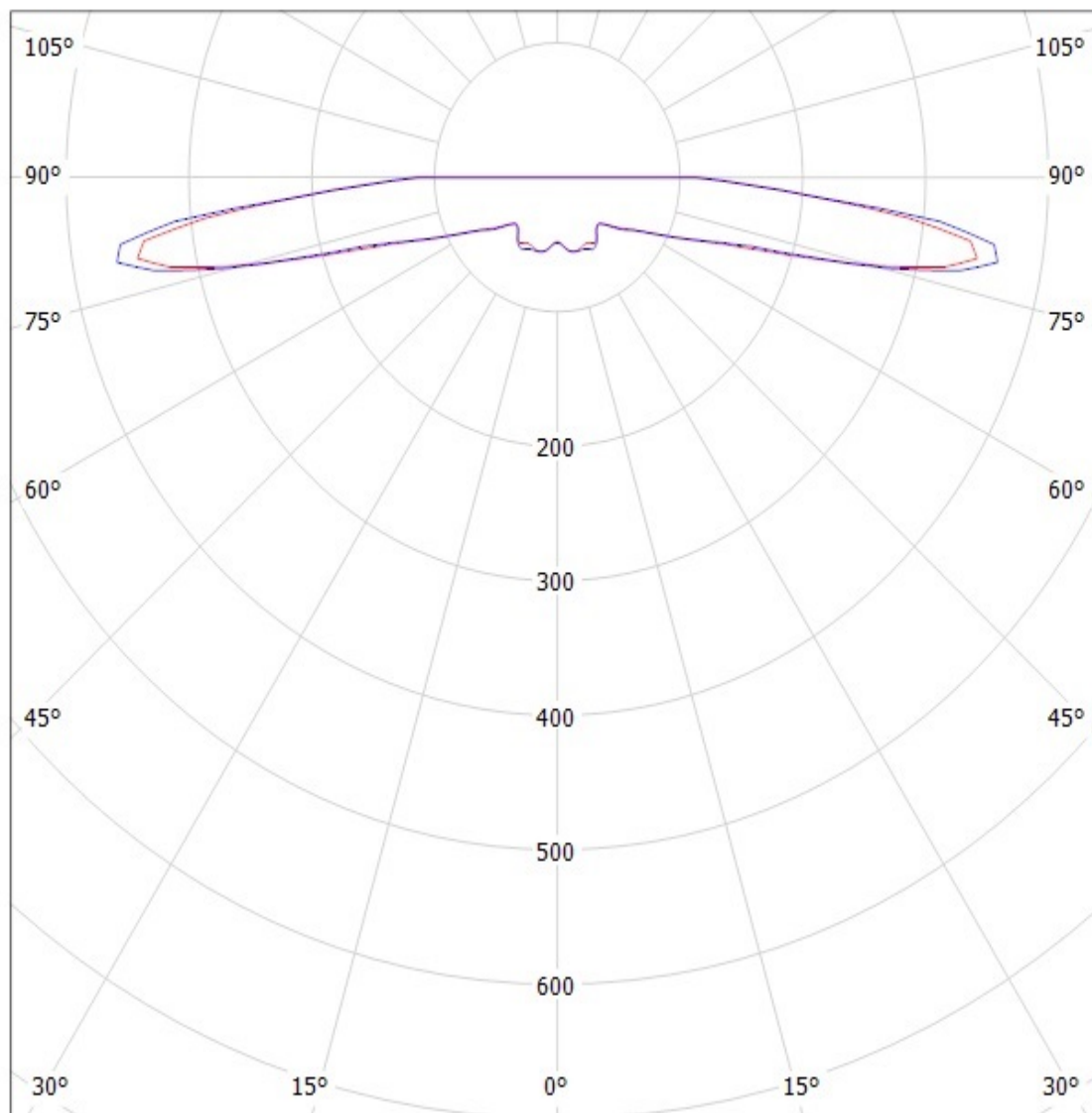

cd/klm

— C0 - C180 — C90 - C270

SIMULATED

Ledil Oy C11249_Strada-S-XP-G C11249_Strada-S-XP-G / LDC (Polar)

Luminaire: Ledil Oy C11249_Strada-S-XP-G C11249_Strada-S-XP-G

Lamps: 1 x Cree XP-G (White)

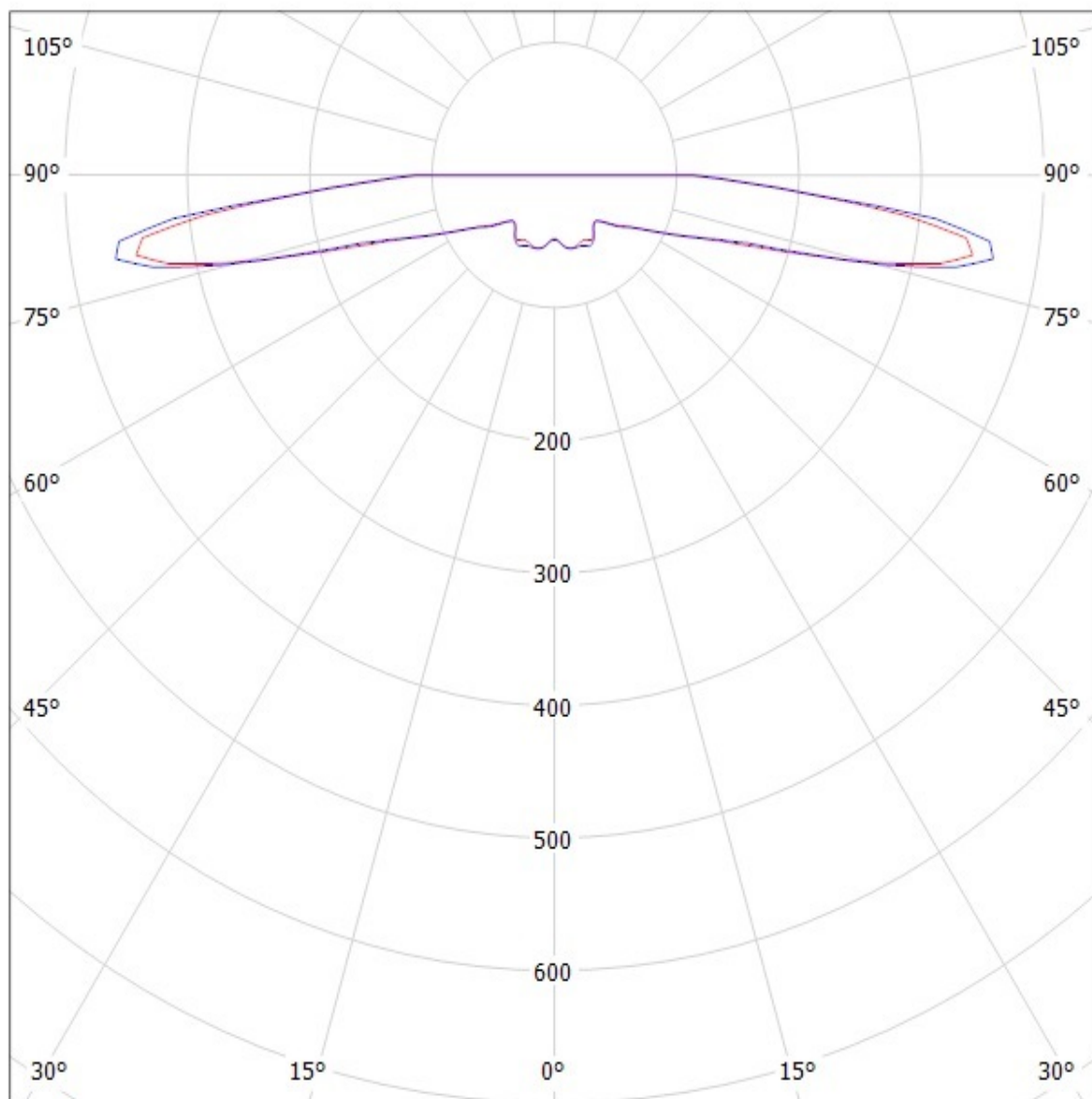

cd/klm

SIMULATED

— C0 - C180

— C90 - C270